

# СТАНДАРТИЗАЦИЯ ФИЗИЧЕСКОЙ ТЕЛЕКОММУНИКАЦИОННОЙ ИНФРАСТРУКТУРЫ

**Каток Виктор Борисович**

Главный советник  
ПАО “Укртелеком”  
[vkatok@ukrtelecom.ua](mailto:vkatok@ukrtelecom.ua)

2019

# ITU Structure

Oldest UN specialized agency (founded in 1865)

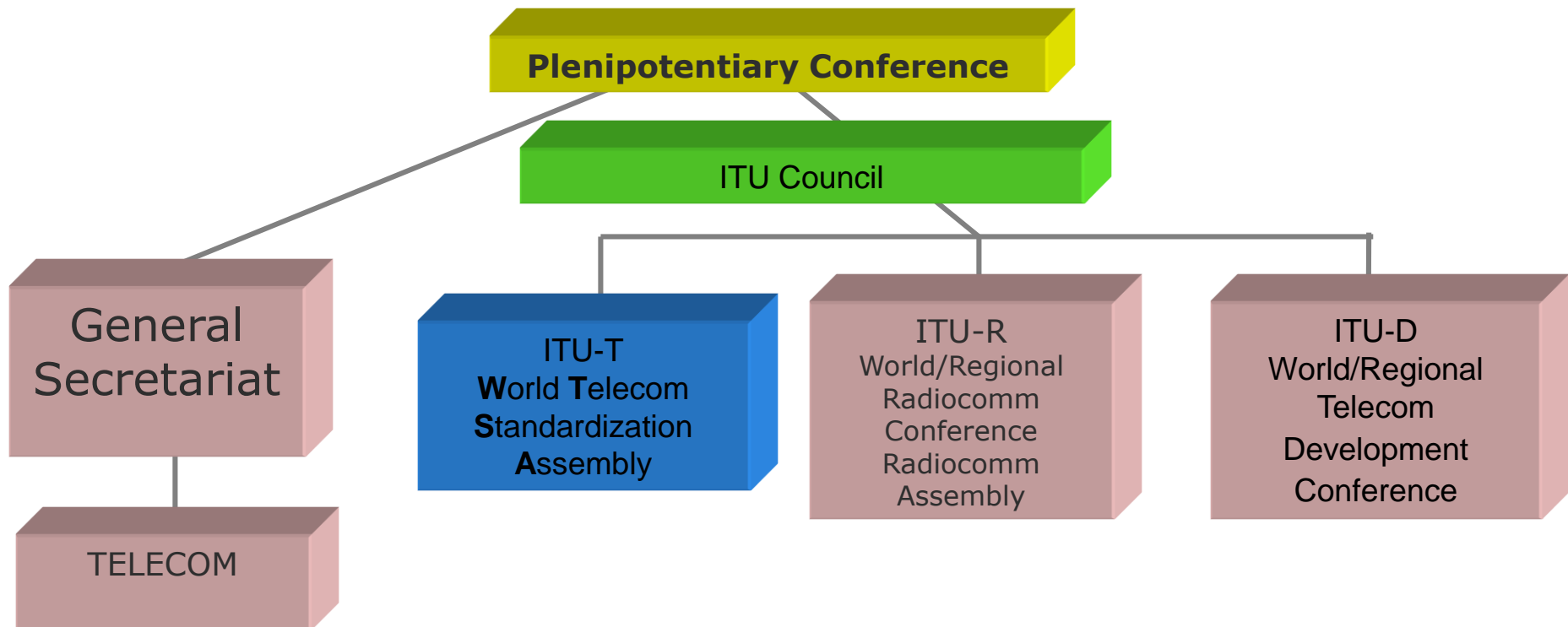

# The future of our wireless networks depends on the future of our wireline networks

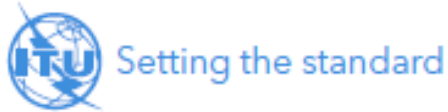

## 2020 vision

-  The future of standardization will be driven by 5G, IoT and Trust
-  WTSA-16 will provide members with a standardization toolkit optimized to assist government and industry in achieving their ambitions for the year 2020 and beyond.

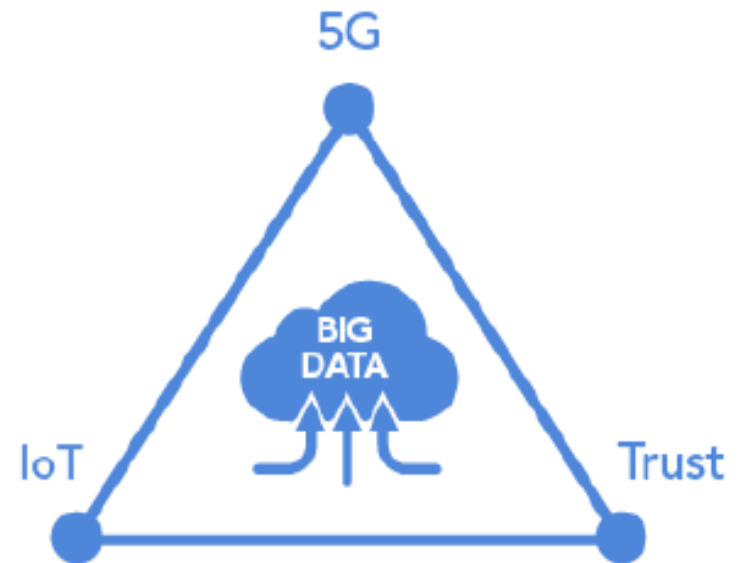



# ITU-T Working Structure

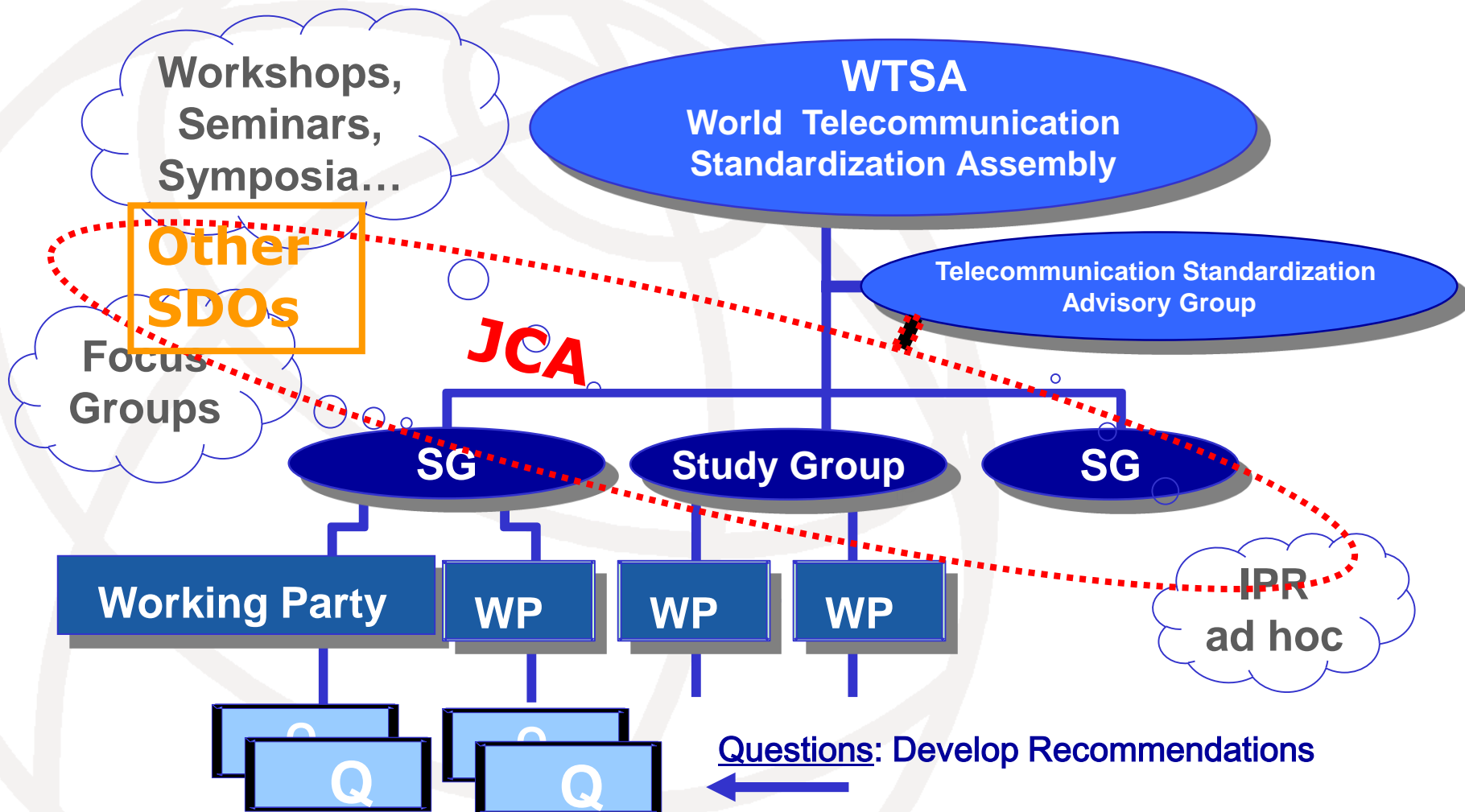

# **15-я Исследовательская комиссия МСЭ-Т**

## **Сети, технологии и инфраструктура для транспортирования, доступа и жилищ**

15-я Исследовательская комиссия МСЭ-Т отвечает в МСЭ-Т за разработку стандартов для инфраструктуры оптических транспортных сетей, сетей доступа, домашних сетей и сетей энергосистем общего пользования, систем, оборудования, оптических волокон и кабелей. Это включает связанные с ними прокладку, техническое обслуживание, управление, испытания, измерительное оборудование и методы измерений, а также технологии плоскости управления, позволяющие осуществлять развитие в направлении интеллектуальных транспортных сетей, включая поддержку приложений "умных" электросетей.

# МСЭ выпустил отчет "Измерение информационного общества" за 2018 год



Растет число людей, имеющих доступ к интернету и пользующихся им. Вместе с тем для повсеместного соединения людей требуются более развитые навыки владения ИКТ, как отмечается в отчете МСЭ "Измерение информационного общества" за 2018 год. В то же время во всем мире в последнее десятилетие значительно снизились расценки на ИКТ. Решающую роль в создании условий для снижения цен сыграло усовершенствование процессов регулирования и разработки политики в области ИКТ, благодаря которому было обеспечено частичное распределение в пользу потребителей выгод за счет обусловленного расширением использования ИКТ повышения эффективности.



THE STATE OF BROADBAND 2018: BROADBAND CATALYZING SUSTAINABLE DEVELOPMENT



**ITU estimates that at the end of 2018, 51.2 per cent of the global population, or 3.9 billion people, were using the Internet.**

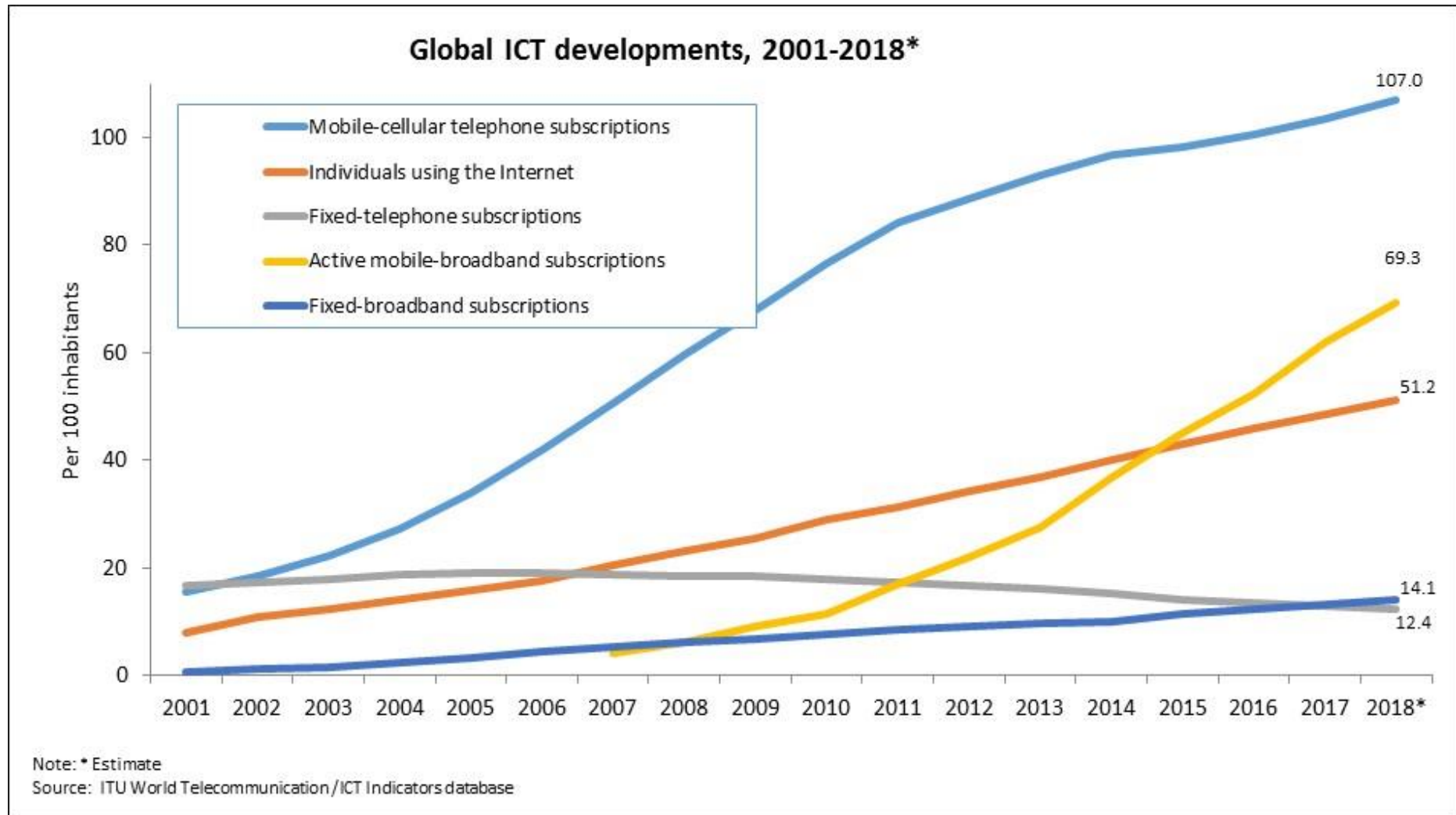

# Fixed-broadband subscriptions by speed, by region

Chart 1.13: Fixed-broadband subscriptions by speed, by region, 2015–2017

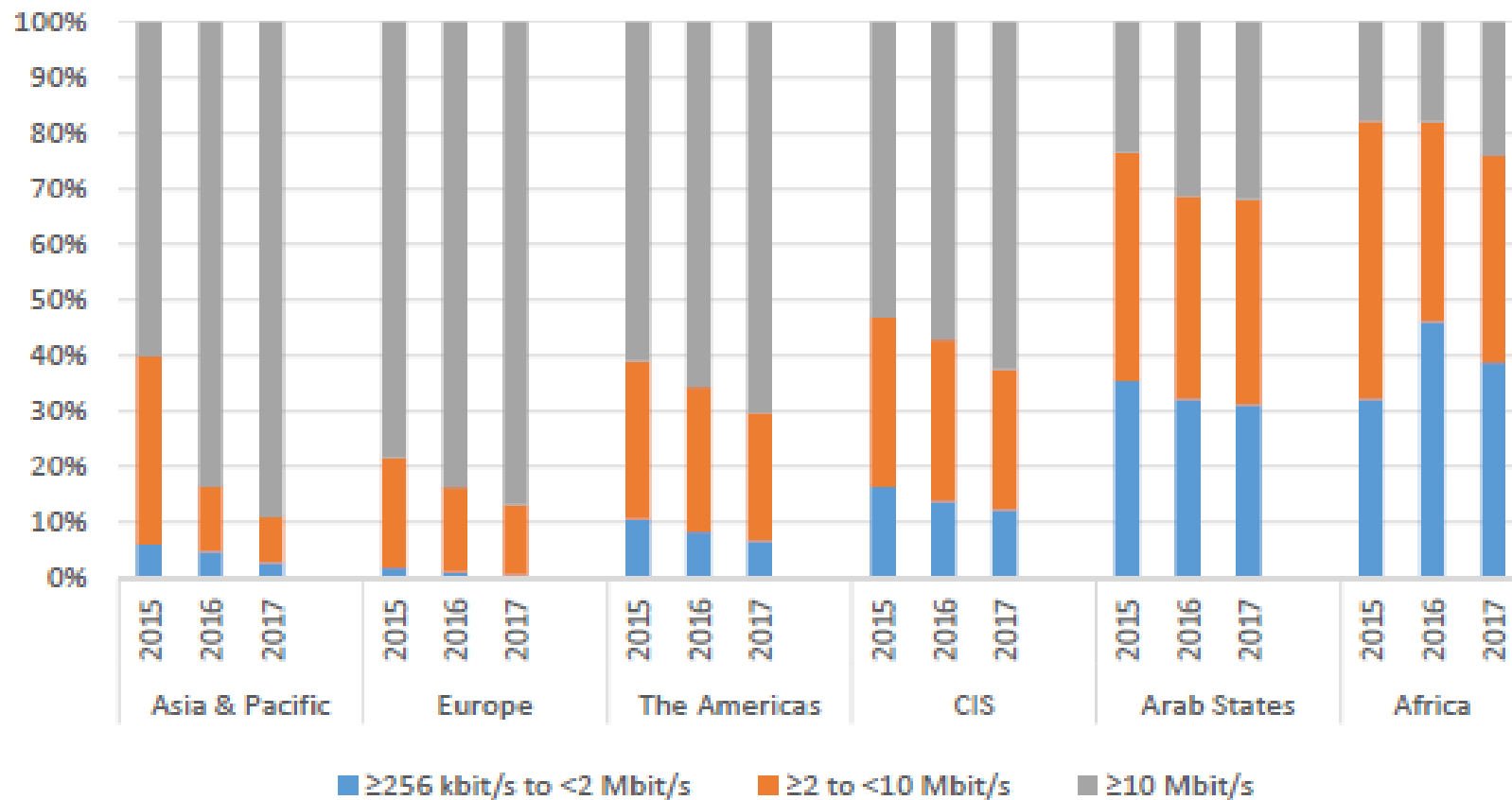

Source: ITU.



**Table 1: Estimates of the Global Market: 2015, 2016, 2017, 2020 and 2021**

	2015	2016	2017	2020	2021
Mobile cellular subscriptions	7.2 bn (ITU) 7.2 bn (GSMA) 7.2 bn (E)	7.4 bn (ITU) 7.5 bn (GSMA) 7.5 bn (E)	7.74 bn (ITU) 7.8 bn (E)	8.3 bn (GSMA) 8.4 bn (E)	8.4 bn (GSMA) 8.6 bn (E)
Unique mobile phone users	4.6 bn (GSMA) 5.0 bn (E)	4.8 bn (GSMA) 5.1 bn (E)	5 bn (GSMA) 5.3 bn (E)	5.4 bn (GSMA) 5.7 bn (E) 5.4 bn (Cisco) <sup>3</sup>	5.5 bn (GSMA) 5.8 bn (E)
LTE subscriptions	1.1 bn (GSMA) 1.1 bn (E) 1.37 bn (ABI Research) <sup>4</sup> 1.068 bn (GSA)	1.8 bn (GSMA) 1.9 bn (E*) 2 bn (Strategy Analytics) <sup>5</sup>	2.6 billion (GSMA) 2.8 bn (E*)	4.1 bn (GSMA) 3.5 bn (ABI) 4.8 bn (E) 3.6 bn (4G Am)	4.5 bn (GSMA) 5.3 bn (E)
5G subscriptions	-/-	-/-	-/-	70 m (GSMA) 55 million (E)	220 m (GSMA) 190 million (E)
Mobile broadband subscriptions	3.2 bn (ITU) 3.4 bn (GSMA) 3.6 bn (E)	3.65 bn (ITU); 4.1 bn (GSMA) 4.5 bn (E)	4.2 bn (ITU) 4.8 bn (GSMA) 5.3 bn (E*)	6.5 bn (GSMA) 7.0 bn (E)	6.9 bn (GSMA) 7.5 bn (E)
Smartphone subscriptions	3.3 bn (GSMA) 3.3 bn (E)	3.9 bn (GSMA) 3.8 bn (E)	4.5 bn (GSMA) 4.4 bn (E*)	5.9 bn (GSMA) 5.8 bn (E)	6.2 bn (GSMA) 6.3 bn (E*)
Fixed broadband (ITU)	820m (ITU)	884m (ITU)	979m (ITU) 1bn (E*)	1.1 bn (E*)	1.2 bn (E*)
Internet users (ITU)	3.21 bn (ITU)	3.49 bn (ITU)	3.58 bn (ITU)	4.16 bn (ITU)	-/-
Facebook users	1.59 bn MAU 1.04 bn DAU <sup>6</sup> (Dec 2015)	1.71 bn MAU 1.13 bn DAU	2.13 bn MAU 1.4 bn DAU	-/-	-/-
LINE users	215 million	217 million	207 million	203 million	-/-
Sina Weibo users	222 million	313 million	392 million	411 million	-/-
Vkontakte users	66.5 million	77.8 million	81.1 million	97 million	-/-
WeChat users	600 million*	806 million	963 million	1 billion	-/-
Smartphone stock	2.2 bn (Del)	-/-	-/-	2.1 bn (BI) <sup>7</sup>	-/-

Source: Various. EST = Estimate. BI= Business Intelligence; Del = Deloitte; Facebook, E = Ericsson Mobility Report June 2018 at: <https://www.ericsson.com/assets/local/mobility-report/documents/2018/ericsson-mobility-report-june-2018.pdf> GSMA = GSMA database.

MAU = monthly active users; DAU = daily active users.

\* Mid-year figures. <https://investor.fb.com/investor-news/press-release-details/2018/Facebook-Reports-Fourth-Quarter-and-Full-Year-2017-Results/default.aspx> and <https://zephoria.com/top-15-valuable-facebook-statistics/>

# Bandwidth and Traffic Speeds for PON

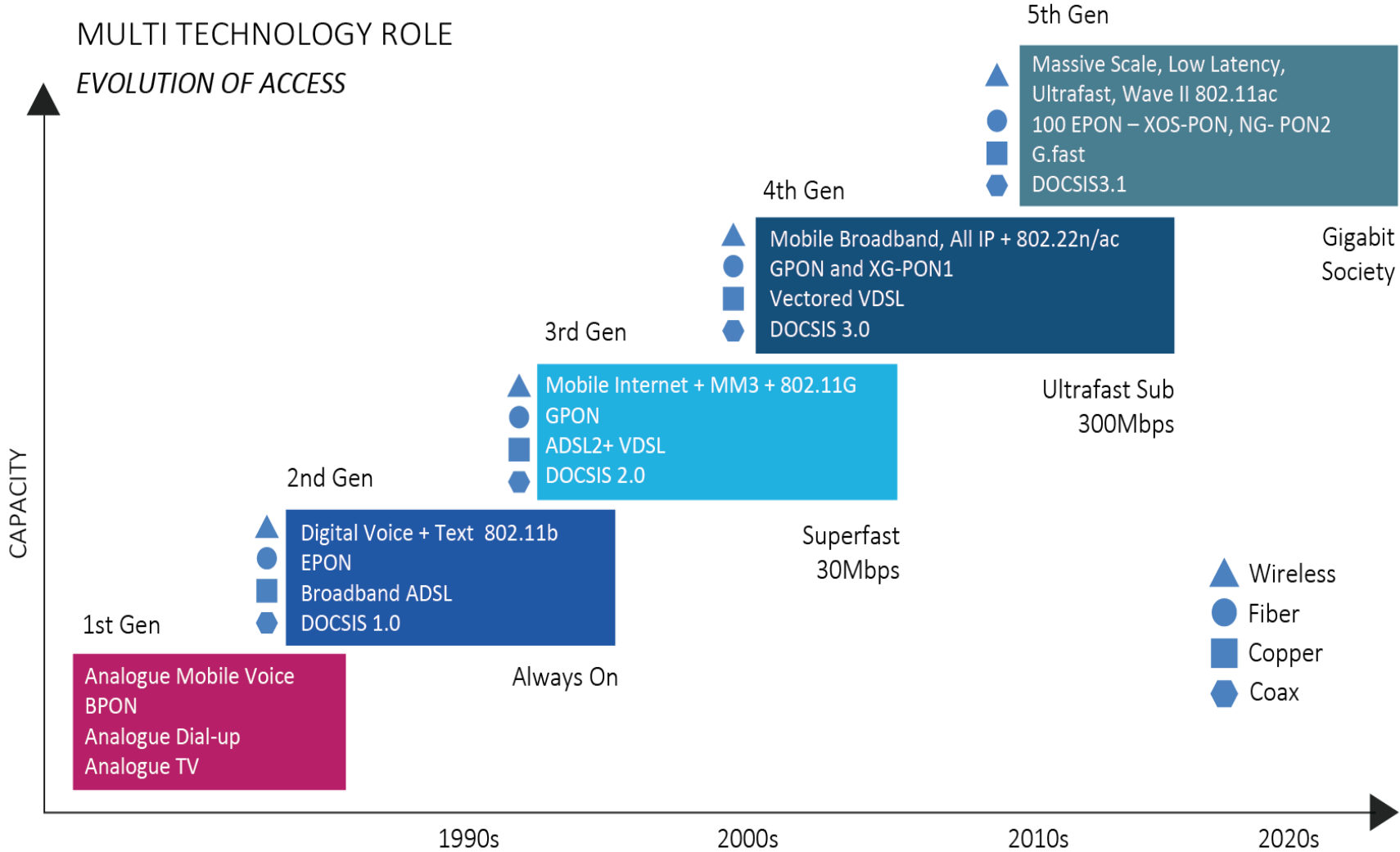

# Bandwidth and Traffic Speeds for PON

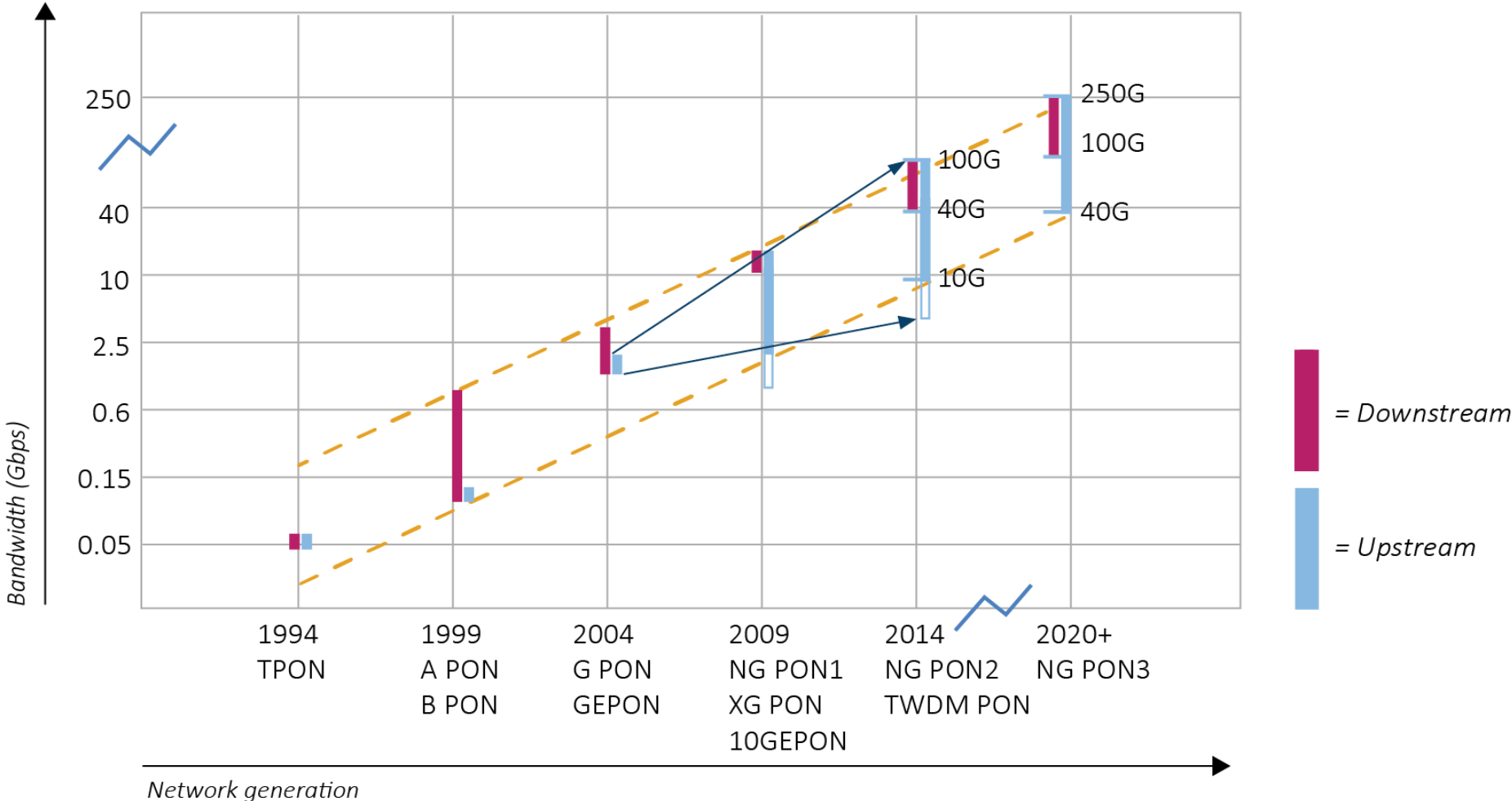

## Директива 2014/61/ЄС Європейського Парламенту та Ради від 15 травня 2014 року про заходи, спрямовані на зменшення витрат на розгортання високошвидкісних мереж електронного зв'язку

Визнаючи важливість розгортання високошвидкісної широкосмугової мережі, держави-члени підтримали амбітні цілі щодо широкосмугового зв'язку, визначені в Повідомленні Комісії під назвою “Цифровий порядок денний для Європи - Європейське зростання за допомогою цифрових технологій” (“Цифровий порядок денний”), а саме забезпечення послугами базового широкосмугового зв'язку всіх громадян Європейського Союзу до 2013 року, і забезпечення до 2020 року доступу для всіх європейців до високошвидкісного Інтернету, понад 30 Мбіт/с, а також більш ніж 50% домогосподарств Європейського Союзу доступом до Інтернету зі швидкістю, що перевищує 100 Мбіт/с.

# Global Ranking at September 2018 – Mature markets

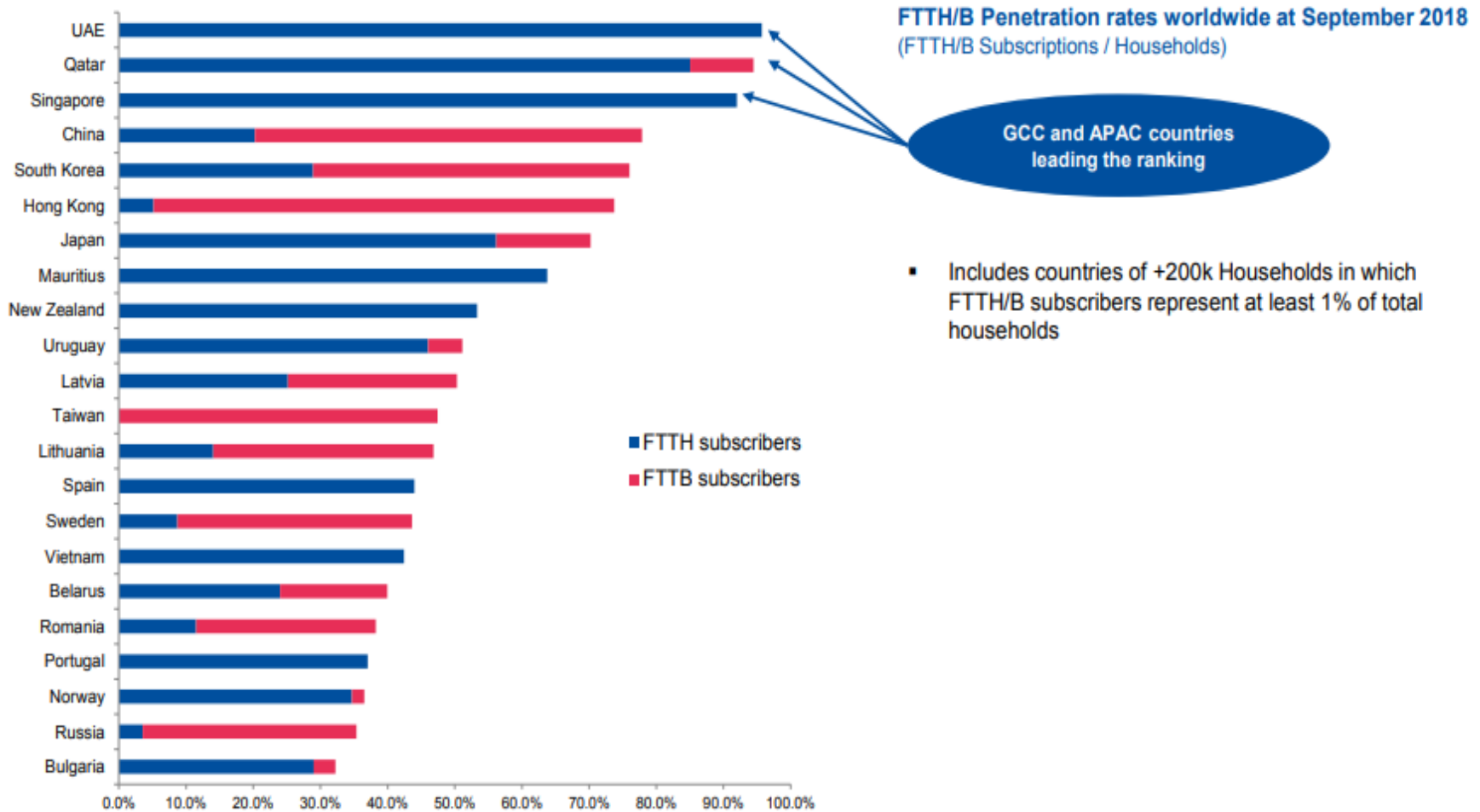

Source: IDATE for FTTH Council EUROPE

# Global Ranking at September 2018 – Less than 30 % penetration

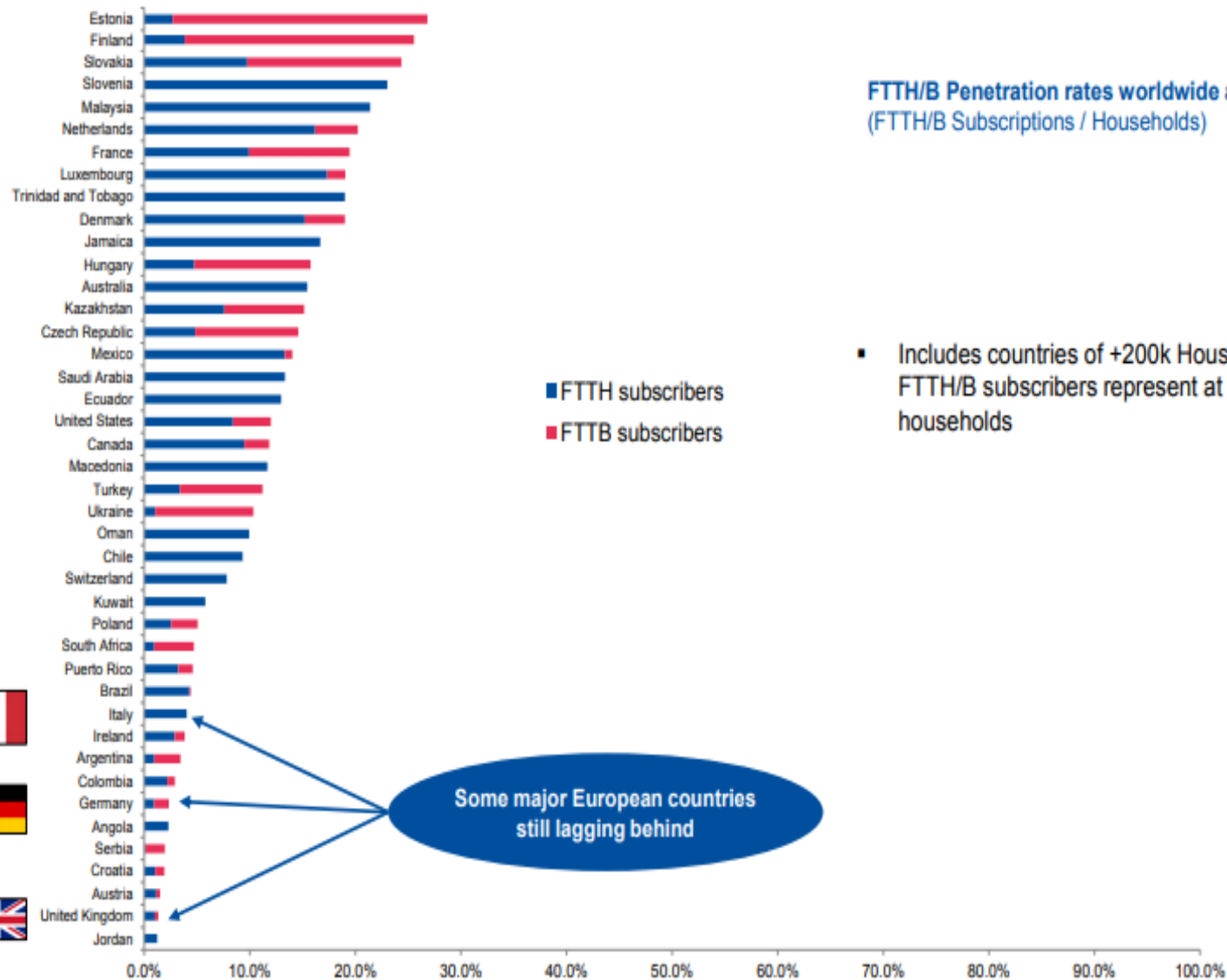

FTTH/B Penetration rates worldwide at September 2018  
(FTTH/B Subscriptions / Households)

- Includes countries of +200k Households in which FTTH/B subscribers represent at least 1% of total households



# FTTH/B Ranking – European ranking

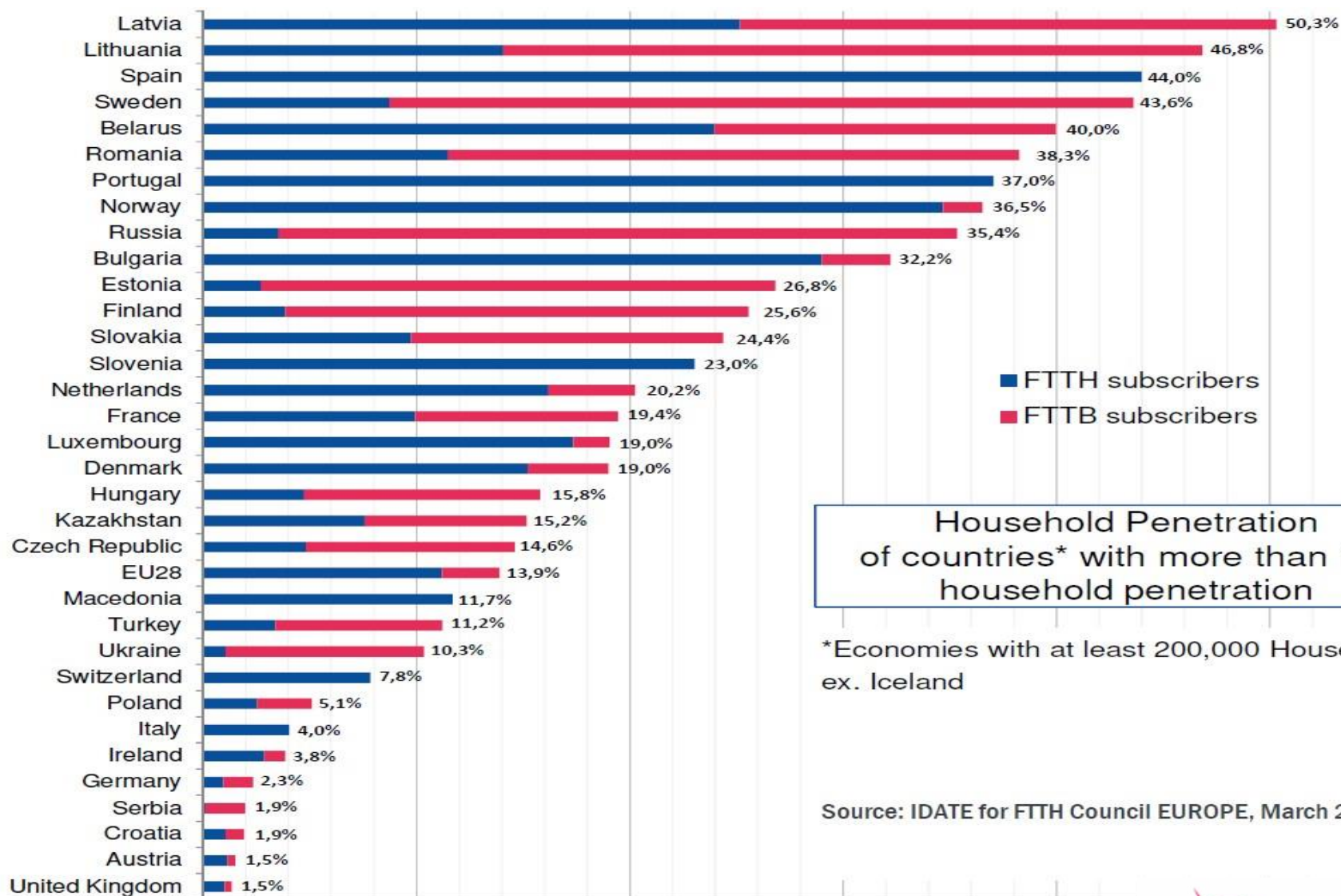

Household Penetration of countries\* with more than 1% household penetration

\*Economies with at least 200,000 Households ex. Iceland

Source: IDATE for FTTH Council EUROPE, March 2019

# General Ranking: FTTH/B Homes passed

European ranking in terms of FTTH/B Homes passed over time (in million homes)  
Data comparison between Sept. 2015 and Sept. 2018

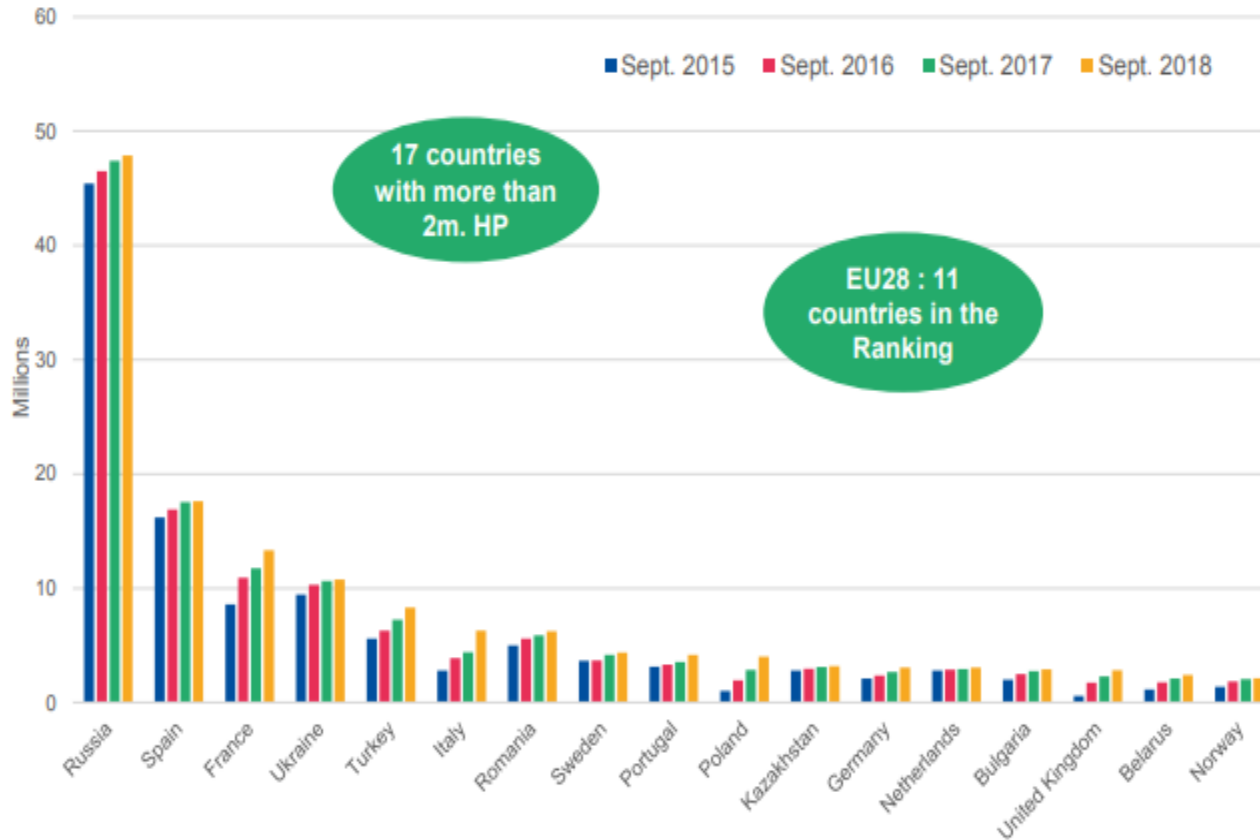

Top 5 annual growth rates – Homes passed (in %)

Data from Sept. 2017 to Sept. 2018

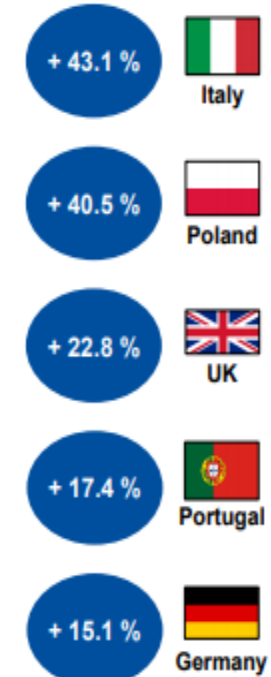

Source: IDATE for FTTH Council EUROPE



# Top 15 Countries by FTTH/B Homes Passed in 2020 & 2025

European ranking in terms of FTTH/B Homes passed (in million homes)

2025 Forecasts  
EU28 : ~166m FTTH H.P.  
EU39 : ~263m FTTH H.P.

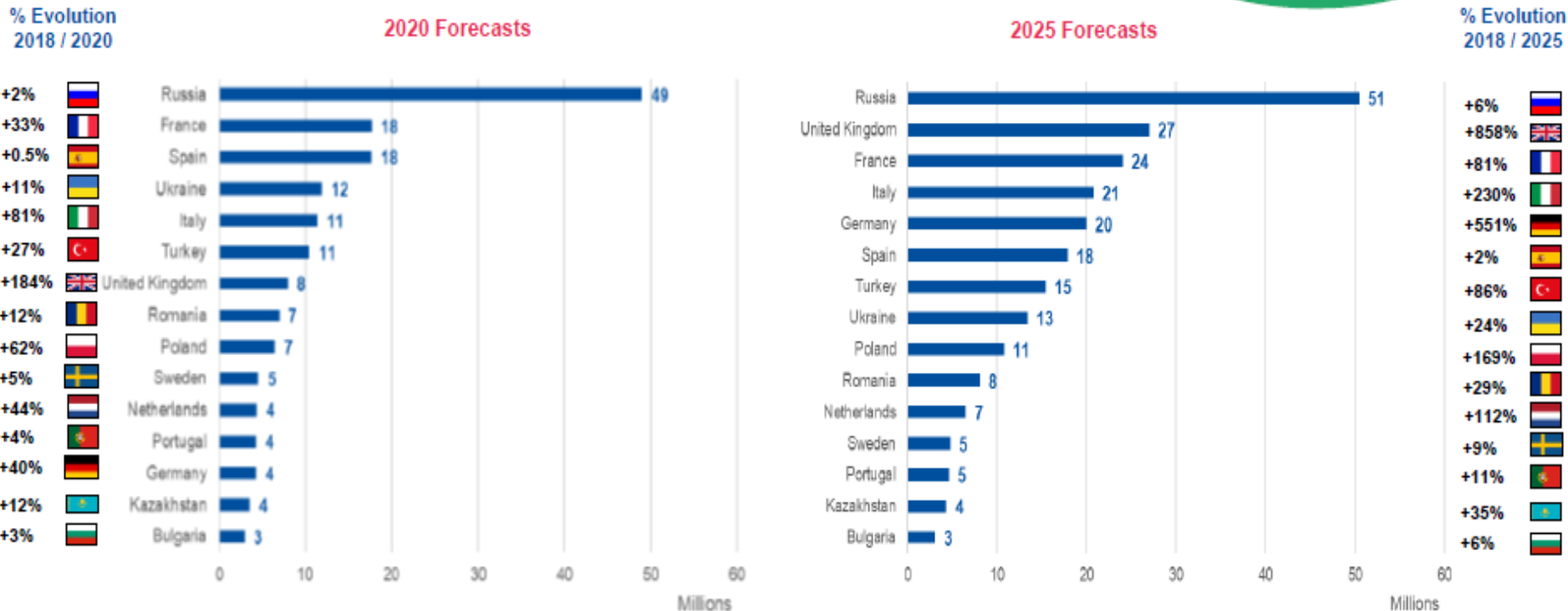

Source: IDATE for FTTH Council EUROPE

# Top 15 Countries by Household penetration

European ranking in terms of Household penetration  
Subscriptions / Households (in %)

2020 Forecasts

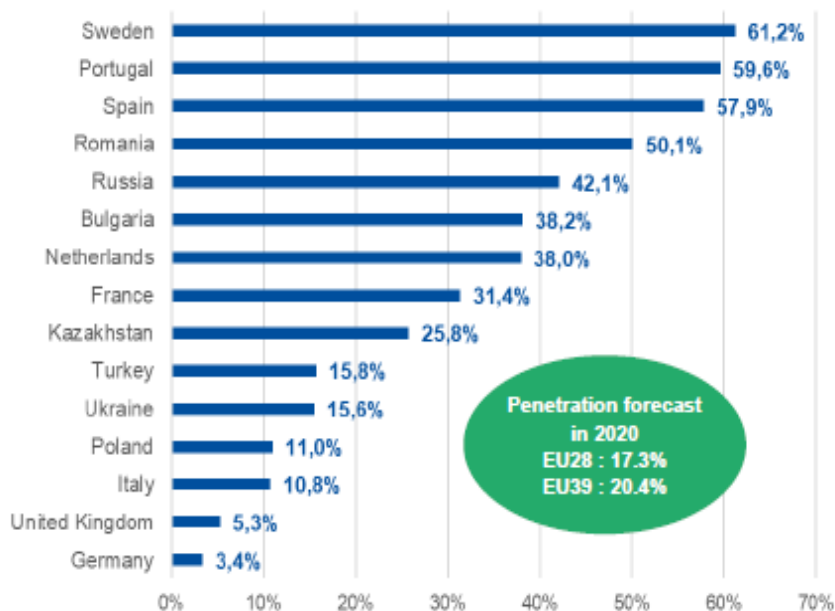

2025 Forecasts

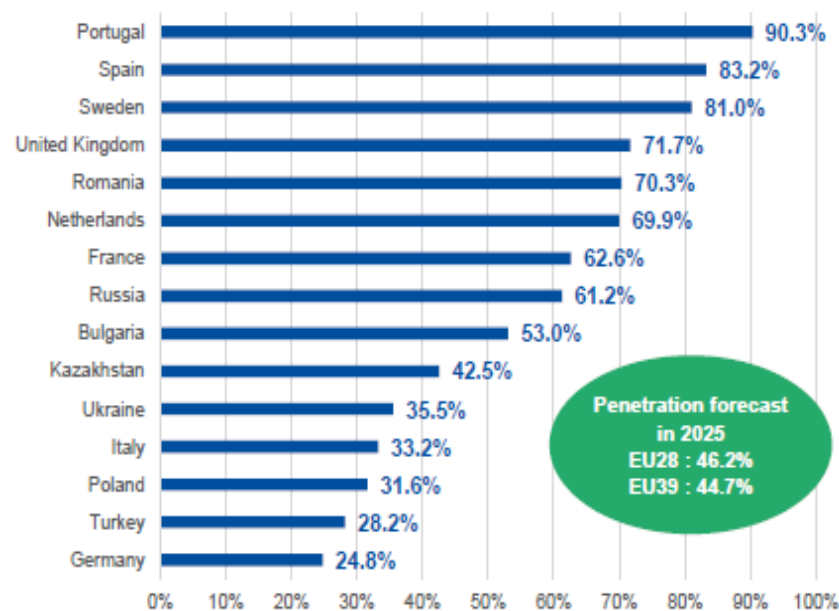

Source: IDATE for FTTH Council EUROPE

## FTTH Architecture & Technology trends

### FTTH / FTTB architecture

Positive FTTH evolution : Fibre closer to end-users by 2025

FTTH/B at Sept. 2018

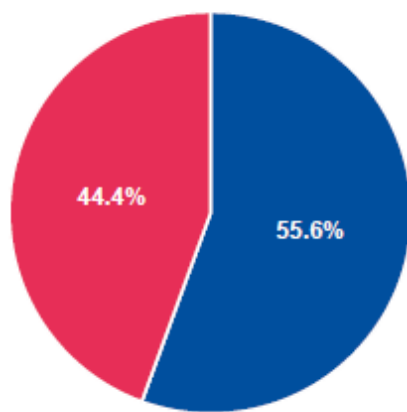

■ FTTH ■ FTTB

2020 Forecasts

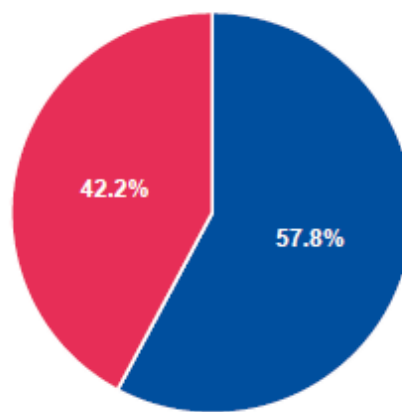

■ FTTH ■ FTTB

2025 Forecasts

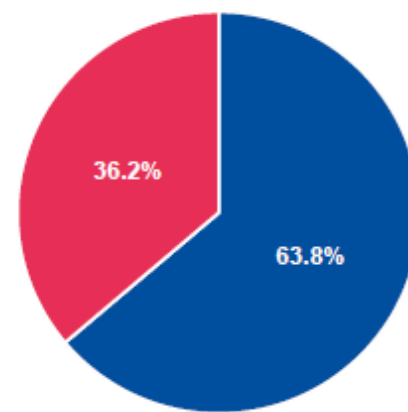

■ FTTH ■ FTTB

Source: IDATE for FTTH Council EUROPE

# Market Panorama & key findings

**The number of fibre to the home (FTTH) and fibre to the building (FTTB) subscribers in Europe increased by 15.7% in EU39 since September 2017 with more than 59.6 million FTTH/B subscribers in September 2018. Although Russia is the leader in terms of FTTH/B subscribers in the European region, it has showed a lower growth rate compared to other European countries which are catching up quickly with a 21% growth.**

The deployment of both FTTH and FTTB networks has increased significantly. By September 2018 it is estimated that **the coverage of FTTH/B reached 46,4% in the EU39 and 36,4% in EU28.** This shows a clear upward trend from September 2015 where the estimated coverage rate in the region was 39% in the EU39 and 27,2% in the EU28.

It is interesting to note that fibre technologies have evolved the last years; by September 2018, we observe a predominance of FTTH architecture over FTTB (**56% vs 44%**).

In the European region, alternative players are the most involved in FTTH/B expansion, with a contribution of around 55% from the FTTH/B total players. We also see that governments and local authorities are getting more involved in fibre projects, either directly, by signing agreements with telecom players, or via public funds. It is also worth noting that incumbents in some countries have started to modify their strategy in order to deploy FTTH solutions, instead of continuing the development of legacy copper-based or cable-based networks.

# Market Panorama & key findings

**The EU 39 includes** Andorra, Austria, Belarus, Belgium, Bulgaria, Croatia, Czechia, Denmark, Estonia, Finland, France, Germany, Greece, Hungary, Iceland, Ireland, Israel, Italy, Kazakhstan, Latvia, Lithuania, Luxembourg, Malta, Macedonia, Netherlands, Norway, Poland, Portugal, Romania, Russia, Serbia, Slovakia, Slovenia, Spain, Sweden, Switzerland, Turkey, Ukraine and United Kingdom

**The EU 28 includes** Austria, Belgium, Bulgaria, Croatia, Cyprus, Czechia, Denmark, Estonia, Finland, France, Germany, Greece, Hungary, Ireland, Italy, Latvia, Lithuania, Luxembourg, Malta, Netherlands, Poland, Portugal, Romania, Slovakia, Slovenia, Spain, Sweden, United Kingdom

## РГ-1. Документы по которым достигли консенсус

Рекомендация	N=нова R=переглянута	Назва
G.989.2	R	40-Gigabit-capable passive optical networks 2 (NG PON2): Physical media dependent (PMD) layer specification
G.988 Amd1	N	ONU management and control interface (OMCI) specification: Amendment 1
G.989.3 Amd2	N	40-Gigabit-capable passive optical networks (NG PON2): Transmission Convergence (TC) layer specification: Amendment 2
G.993.2	R	Very high speed digital subscriber line transceivers 2 (VDSL2)
G.993.5	R	Self-FEXT cancellation (vectoring) for use with VDSL2 transceivers
G.994.1	R	Handshake procedures for digital subscriber line transceivers
G.996.2	R	Single-ended line testing for digital subscriber lines (DSL)
G.997.1	R	Physical layer management for digital subscriber line transceivers
G.997.2	R	Physical layer management for G.fast transceivers
G.998.2	R	Ethernet-based multi-pair bonding
G.998.4	R	Improved impulse noise protection for digital subscriber line (DSL) transceivers
<sup>22</sup> G.999.1	R	Interface between the link layer and the physical layer for digital subscriber line (DSL) transceivers

## РГ-1. Документы по которым достигли консенсус (Продолжение)

G.9701	R	Fast access to subscriber terminals (G.fast) - Physical layer specification
G.9807.2 Amd1	N	10 Gigabit-capable symmetrical passive optical networks (XG(S)-PON): Reach extension: Amendment 1
G.9960	R	Unified high-speed wire-line based home networking transceivers – System architecture and physical layer specification
G.9961	R	Unified high-speed wireline-based home networking transceivers – Data link layer specification
G.9962	R	Unified high-speed wireline-based home networking transceivers – Data link layer specification
G.9963	R	Unified high-speed wireline-based home networking transceivers – Multiple input/multiple output specification
G.9979	R	Implementation of the generic mechanism in the IEEE 1905.1a-2014 Standard to include applicable ITU-T Recommendations
G.9991	N	High speed indoor visible light communication transceiver – System architecture, physical layer and data link layer specification
G.9992	N	Indoor optical camera communication transceivers – System architecture, physical layer and data link layer specification
G.9978	R	Secure admission in G.hn network
<sup>23</sup> G.9803 (ex. G.RoF)	N	Radio over fiber systems

## РГ-2. Документы по которым достигли консенсус

Рекомендация	N=новая R=перег- лянутa	Назва
G.651.1	R	Characteristics of a 50/125 $\mu\text{m}$ multimode graded index optical fibre cable for the optical access network
G.698.2	R	Amplified multichannel dense wavelength division multiplexing applications with single channel optical interfaces
G.698.4 Cor.1	N	Multichannel bi-directional DWDM applications with port agnostic single-channel optical interfaces
G.672	R	Characteristics of multi-degree reconfigurable optical add/drop multiplexers
L.163	N	Criteria for optical fibre cable installation with minimal existing infrastructure
L.109	R	Construction of optical/metallic hybrid cables
L.314	R	Optical fibre identification for the maintenance of optical access networks



## РГ-3. Документы по которым достигли консенсус

Рекомендація	N=нова R=переглянута	Назва
G.8131 Amd.3	N	Linear protection switching for MPLS transport profile
G.8011/Y.1307	R	Ethernet service characteristics
G.8013/Y.1731 Amd.1	N	Operation, administration and maintenance (OAM) functions and mechanisms for Ethernet-based networks
G.8121/Y.1381	R	Characteristics of MPLS-TP equipment functional blocks
G.8121.1/Y.1381.1	R	Characteristics of MPLS-TP equipment functional blocks supporting ITU-T G.8113.1/Y.1372.1 OAM mechanisms
G.8121.2/Y.1381.2	R	Characteristics of MPLS-TP equipment functional blocks supporting ITU-T G.8113.2/Y.1372.2 OAM mechanisms
G.709/Y.1331 (2016) Amd.3	N	Interfaces for the optical transport network (OTN): Amendment 3
G.709.1/Y.1331.1 (2018) Amd.1	N	Flexible OTN short-reach interface - Amendment 1
G.709.3/Y.1331.3 Amd.1	N	Flexible OTN long-reach interfaces – Amendment 1
G.8023 (2018) Cor.1	N	Characteristics of equipment functional blocks supporting Ethernet physical layer and FlexE interfaces - Corrigendum 1

### РГ-3. Документы по которым достигли консенсус (Продолжение)

G.8251	R	The control of jitter and wander within the optical transport network (OTN)
G.8260 (2015) Amd.2	N	Definitions and terminology for synchronization in packet networks: Amendment 2
G.8262	R	Timing characteristics of synchronous equipment slave clock
G.8262.1/Y.1362.1	N	Timing characteristics of enhanced synchronous equipment slave clock
G.8271 Amd 2	N	Time and phase synchronization aspects of telecommunication networks - Amendment 2
G.8271.2 Amd.2	N	Network limits for time synchronization in packet networks with partial timing support from the network - Amendment 2
G.8272	R	Timing characteristics of primary reference time clocks
G.8273.2/Y.1368.2 Amd.2	N	Timing characteristics of telecom boundary clocks and telecom time slave clocks - Amendment 2
G.8273.3/Y.1368.3 Amd.1	N	Timing characteristics of telecom transparent clocks - Amendment 1
G.8275/Y.1369 Amd.1	N	Architecture and requirements for packet-based time and phase distribution Amendment 1
G.875	R	Optical transport network: Protocol-neutral management information model for the network element view
G.8052/Y.1346	R	Protocol-neutral management information model for the Ethernet Transport capable network element
G.8151/Y.1374	R	Management aspects of the MPLS-TP network element
G.8152/Y.1375	R	Protocol-neutral management information model for the MPLS-TP network element
G.7721 26	N	Management Requirement and Information Model for Synchronization

# Home networking

## **Recommendation ITU-T G.9960. Unified high-speed wire-line based home networking transceivers - System architecture and physical layer specification**

### Summary

Recommendation ITU-T G.9960 belongs to the family of ITU-T G.996x Recommendations. Recommendation ITU-T G.9960 specifies the system architecture and physical (PHY) layer for wireline-based home networking transceivers, which are capable of operating over premises' wiring, including inside telephone wiring, coaxial cable, and power-line wiring.

## **Recommendation ITU-T G.9991. High speed indoor visible light communication transceiver – System architecture, physical layer and data link layer specification**

### Summary

Recommendation ITU-T G.9991 specifies the system architecture, physical (PHY) layer and data link layer (DLL) for high-speed indoor optical wireless communication transceiver using visible light

## **Recommendation ITU-T G.9992 Indoor optical camera communication transceiver – System architecture, physical layer and data link layer specification**

### Summary

Recommendation ITU-T G.9992 specifies the system architecture, physical (PHY) layer and data link layer (DLL) for indoor optical camera communication transceiver.



Setting the standard



**95%**

International traffic carried  
over fibre networks built  
using  
ITU standards

ITU-T continues to provide leadership  
in the standardization of networks,  
technologies and infrastructures for  
transport and access.

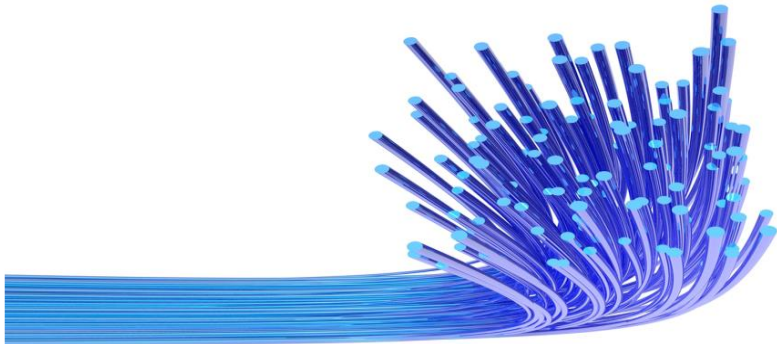

# ИНТЕРЕС К ВОЛС ВОЗРАСТАЕТ НА ВСЕХ УРОВНЯХ

Cebit 2014: Die Datenkrake zähmen



Bundeskanzlerin Angela Merkel (CDU) und der britische Premierminister David Cameron (I) lassen sich am Stand der Telekom Glasfasern erklären.  
Foto: dpa



# ITU-T G.65x-series Recommendations

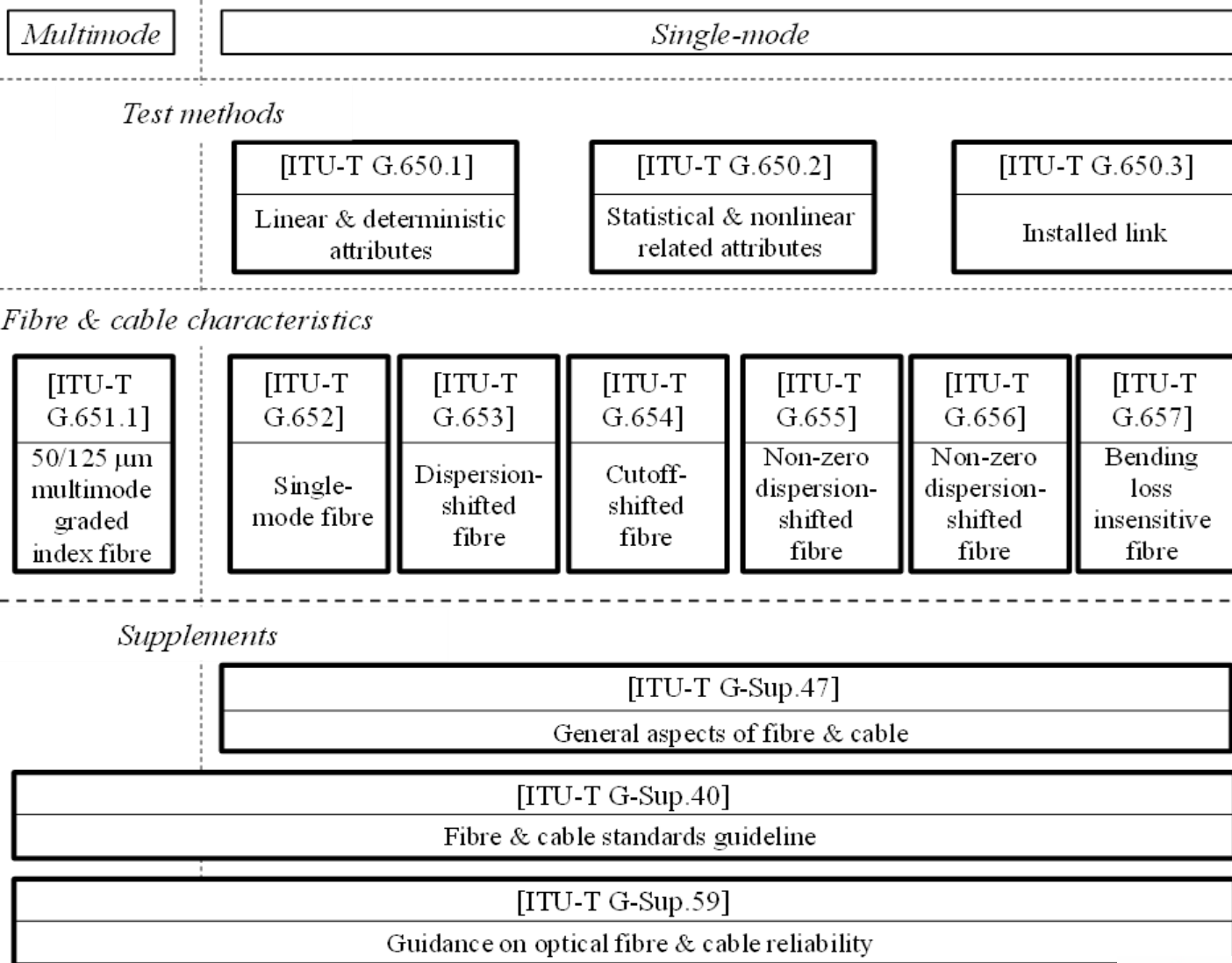

# Renumbering for new technical classification of ITU-T L-series Recommendations

Technical area		Assigned Questions			
	Sub-category	Q7/15	Q8/15	Q16/15	Q17/15
Optical fibre cables L.100 – L.199	Cable structure and characteristics (L.100 –L.124)			L.10, L.26, L.43, L.58, L.59, L.60, L.67, L.78, L.79, L.87, L.110	
	Cable evaluation (L.125 –L.149)			L.14, L.27	
	Guidance and installation technique (L.150 – L.199)			L.34, L.35, L.38, L.46, L.48, L.49, L.56, L.57, L.61, L.77, L.82, L.83, L.162	
Optical infrastructures L.200 – L.299	Infrastructure including node element (except cables) (L.200 – L.249)			L.11, L.13, L.44, L.50, L.51, L.70, L.206, L.207	
	General aspects and network design (L.250 – L.299)			L.17, L.39, L.45, L.47, L.62, L.63, L.72, L.73, L.84, L.86, L.89, L.90, L.94	
Maintenance and operation L.300 – L.399	Optical fibre cable maintenance (L.300 – L.329)				L.25, L.40, L.41, L.53, L.66, L.68, L.85, L.93, L.315
	Infrastructure maintenance (L.330 – L.349)				L.74, L.88
	Operation support and infrastructure management (L.350 – L.379)				L.64, L.69, L.80
	Disaster management (L.380 – L.399)				L.81, L.92, L.392
Passive optical devices L.400 – L.429		L.12, L.31, L.36, L.37, L.404			
Multiplexed terrestrial cables L.430 – L.449			L.28, L.29, L.30, L.54, L.55		

# Optical fibre cable structures

- L.100: Optical fibre cables for duct and tunnel application
- L.101: Optical fibre cables for buried application
- L.102: Optical fibre cables for aerial application
- L.103: Optical fibre cables for indoor applications
- L.104: Small count optical fibre cables for indoor applications
- L.105: Optical fibre cables for drop applications
- L.106: Optical fibre cables: Special needs for access network
- L.107: Optical fibre cable construction for sewer duct applications
- L.108: Optical fibre cable elements for microduct blowing-installation application
- L.109: Construction of optical/metallic hybrid cables
- L.110: Optical fibre cables for direct surface application
- G.978: Characteristics of optical fibre submarine cables



# Construction and installation practices

The following ITU-T Recommendations are related to construction and installation practices.

Recommendation ITU-T L.152/L.38, *Use of trenchless techniques for the construction of underground infrastructures for telecommunication cable installation.*

Recommendation ITU-T L.153/L.48, *Mini-trench installation technique.*

Recommendation ITU-T L.154/L.49, *Micro-trench installation technique.*

Recommendation ITU-T L.250/L.90, *Optical access network topologies for broadband services.*

Recommendation ITU-T L.158/L.56, *Installation of optical fibre cables along railways.*

Recommendation ITU-T L.156, *Air-assisted installation of optical fibre cables.*

Recommendation ITU-T L.157/L.61, *Optical fibre cable installation by floating technique.*

Recommendation ITU-T L.258/L.63, *Safety procedures for outdoor installations.*

Recommendation ITU-T L.159/L.77, *Installation of optical fibre cables inside sewer ducts.*

Recommendation ITU-T L.108, *Optical fibre cable elements for microduct blowing-installation application.*

Recommendation ITU-T L.155, *Low impact trenching technique for FTTx networks.*

# Detailed reference point-to-point network

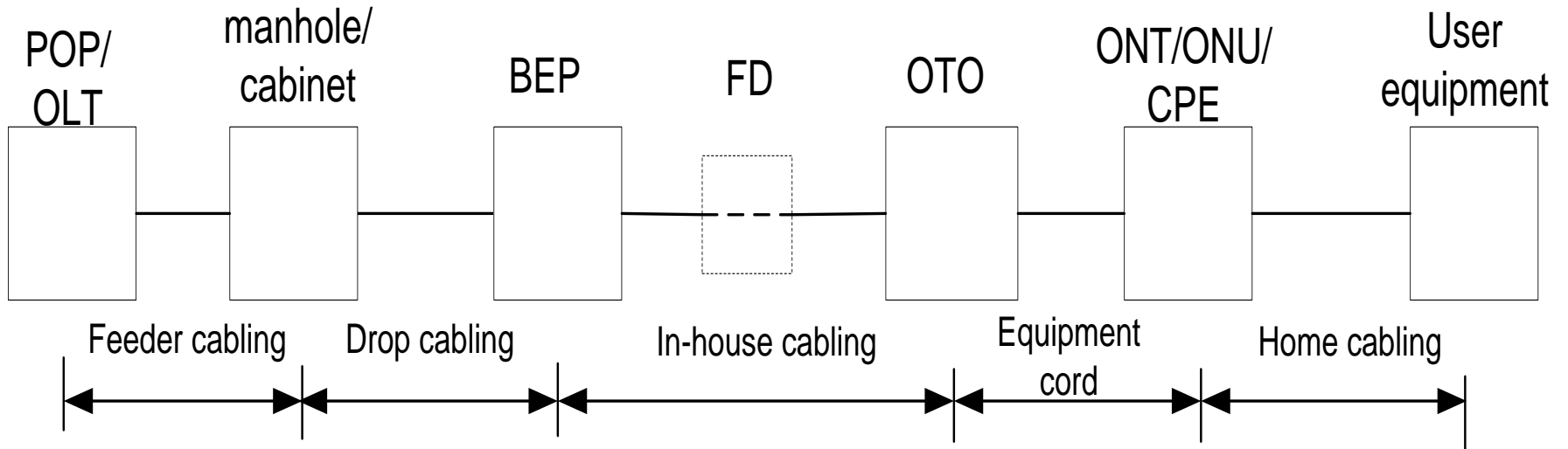

BEP Building Entry Point  
FD Floor Distributor  
OTO Optical Telecommunications Outlet

# Status of single-mode optical fibre specifications in ITU-T and IEC

Optical fibre specification			
ITU-T		IEC	
Fibre category	Recommendation	Fibre category	Document
Single-mode optical fibre	[ITU-T G.652]	B-652(ex.B1.1 / ex.B1.3) single-mode fibre	[IEC 60793-2-50]
Dispersion-shifted single-mode optical fibre	[ITU-T G.653]	B-653 (ex. B2) single-mode fibre	
Cut-off shifted single-mode optical fibre	[ITU-T G.654]	B-654 (ex. B1.2) single-mode fibre	
Non-zero dispersion shifted single-mode optical fibre	[ITU-T G.655]	B-655 (ex. B4) single-mode fibre	
Non-zero dispersion shifted single-mode optical fibre for wideband optical transport	[ITU-T G.656]	B-656 (ex. B5) single-mode fibre	
Bending loss insensitive single-mode optical fibre	[ITU-T G.657]	B-657 (ex. B6) single-mode fibre	

NOTE – New fibre designations, e.g. “B-652”, have been agreed at 2016 IEC SC86A meeting. Designation found in bracket “(ex. Bx.x)” corresponds to the description found in [IEC 60793-2-50] published in 2015<sup>th</sup> or before.

# Status of multimode optical fibre specifications in ITU-T, IEC and ISO/IEC

Attribute		ITU-T	ISO/IEC 11801-1				
ITU-T Recommendation and ISO/IEC designation		G.651.1	OM1	OM2	OM3	OM4	OM5
Core diameter (mm)		50	62.5	50	50	50	50
ITU-T fibre type cross-reference				G.651.1			
IEC fibre type cross-reference [IEC 60793-2-10]		A1-OM2	A1-OM1	A1-OM2	A1-OM3	A1-OM4	A1-OM5
Minimum modal bandwidth-length product for overfilled launch (MHz·km)	850 nm	500	200	500	1500	3500	3500
	1300 nm	500	500	500	500	500	500

# Новые направления стандартизации

## Draft new Recommendation ITU-T L.osp

### **Optical fibre cables for general outdoor application in buried, duct, and lashed/connected aerial cable plant**

Recommendation ITU-T L.osp coordinates with the cable ITU-T Recommendations L.100, L.101, and L.102. It defines a cable, which may be used in all of the application spaces of these Recommendations—general buried plant, underground plant in ducts, and aerial plant where the cable is lashed or connected to a messenger wire.

## Draft new Recommendation ITU-T L.fdb

### **Requirements for passive optical nodes: Fibre distribution boxes**

Recommendation ITU-T L.fdb refers to fibre distribution boxes (FDB) deployed as passive optical nodes in indoor or outdoor environments. It deals with the box housing, fibre management system, cable attachment and termination system, and specifies the mechanical and environmental characteristics as well.

## Draft new Recommendation ITU-T L.oha

### **Optical fibre cables for in-home applications**

This Recommendation aims to provide the requirements of optical fibre cables for in-home applications. Compared to requirements of optical fibre cables in traditional “indoor” applications, the requirements of cables in “in-home” applications have their own specialized characteristics. This new recommendation describes characteristics, cable construction and test methods of optical fibres and cables for in-home applications.

# Proposed final organization of outdoor cable Recommendations

Application spaces (system approach)

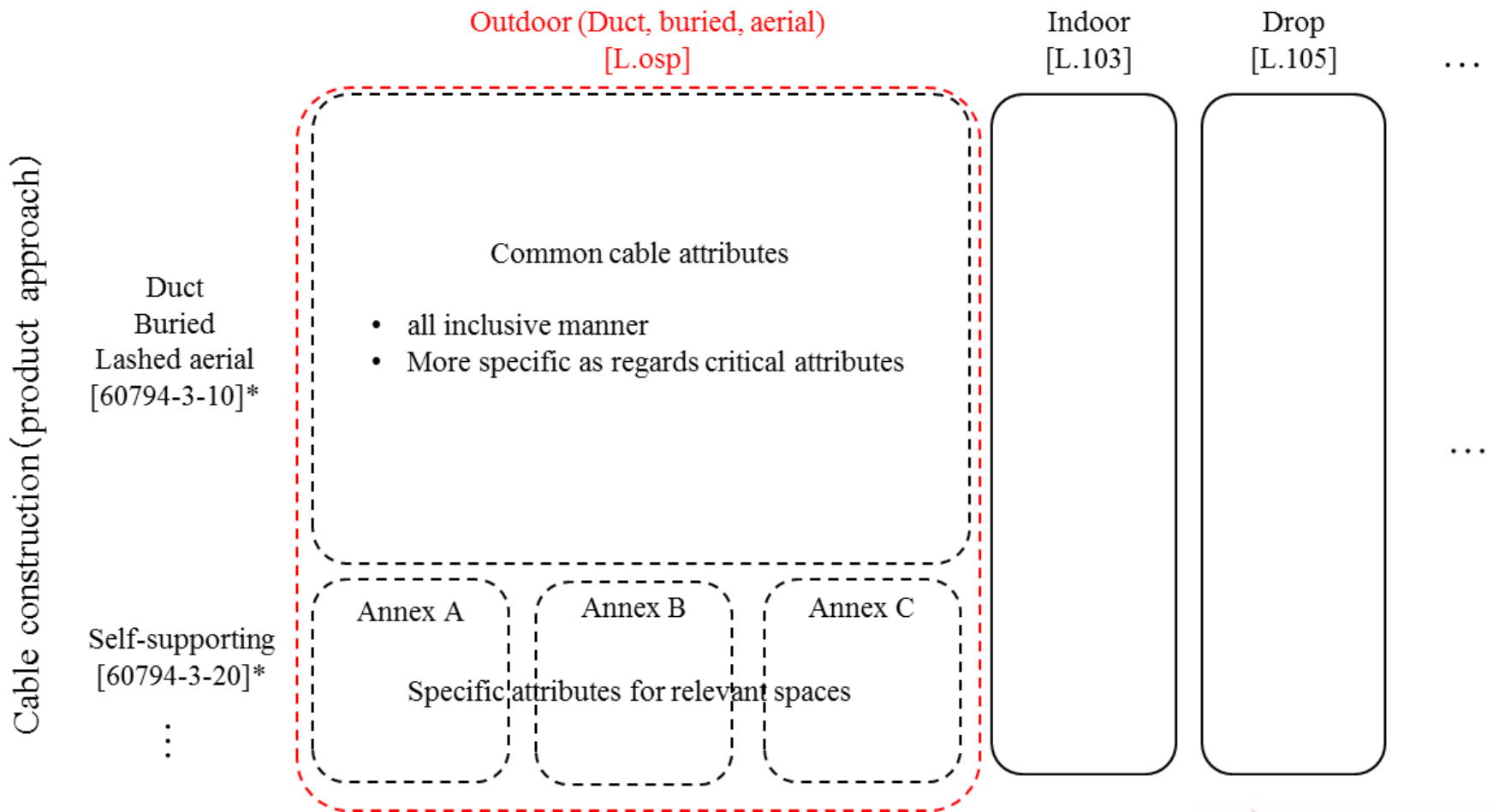

Firstly, create general Rec. L.ocgen

### General Recommendation for outdoor (L.ocgen)

- General principles and definitions\ cable characteristics\ elements of cable constructions
- Common environmental conditions cables may be used in;
- General test scheme and cross references of test methods;
- Other general issues.

### Separate Recommendations for specific applications

- Specific cable characteristics / cable constructions for the applications;
- Detailed technical specifications (test parameters and performance specifications according to applications);
- Annexes and appendixes (normative contents specially used in the Rec., and informative experiences shared by countries and companies);
- other specific issues.

L.100  
Duct,  
tunnel

L.101  
Buried

L.102  
Aerial

L.107  
Sewer  
duct

L.108, L.110,  
L.osp  
.....

Then, revise the existing Recs. flexibly when necessary.

### Advantages:

a) **Structural and systematic** organization.

— Common information (environmental conditions, common test items and methods) are given and unified in the general Rec. No need to be repeated again and again;

—The specific Recs. can get **harmonized** with each other easily;

—New Recs. are easy to be developed by following L.ocgen;

b) Takes **all** current, under developing and possible future outdoor Recs into consideration;

— Revisions of current Recs. can be done **step by step** when necessary, without disturbing each other;

— New Recs. can be created **freely** for new cable applications and structures, instead of opening the only Rec. to add Annexes;

c) **Easier** and **more flexible** for maintenances and expansions (ITU-T Recs are **free for users**, number is not a key problem);

d) Appendixes in current Recs **contributed by various countries and companies** can be directly kept in separated Recs, and new things and experiences are easy to be added.

**Disadvantage:** Longer procedure of the overall re-organization. (Longer, but stable)

# Proposed “general Rec.- Specific Recs.” structure of organizing outdoor cable Recommendations

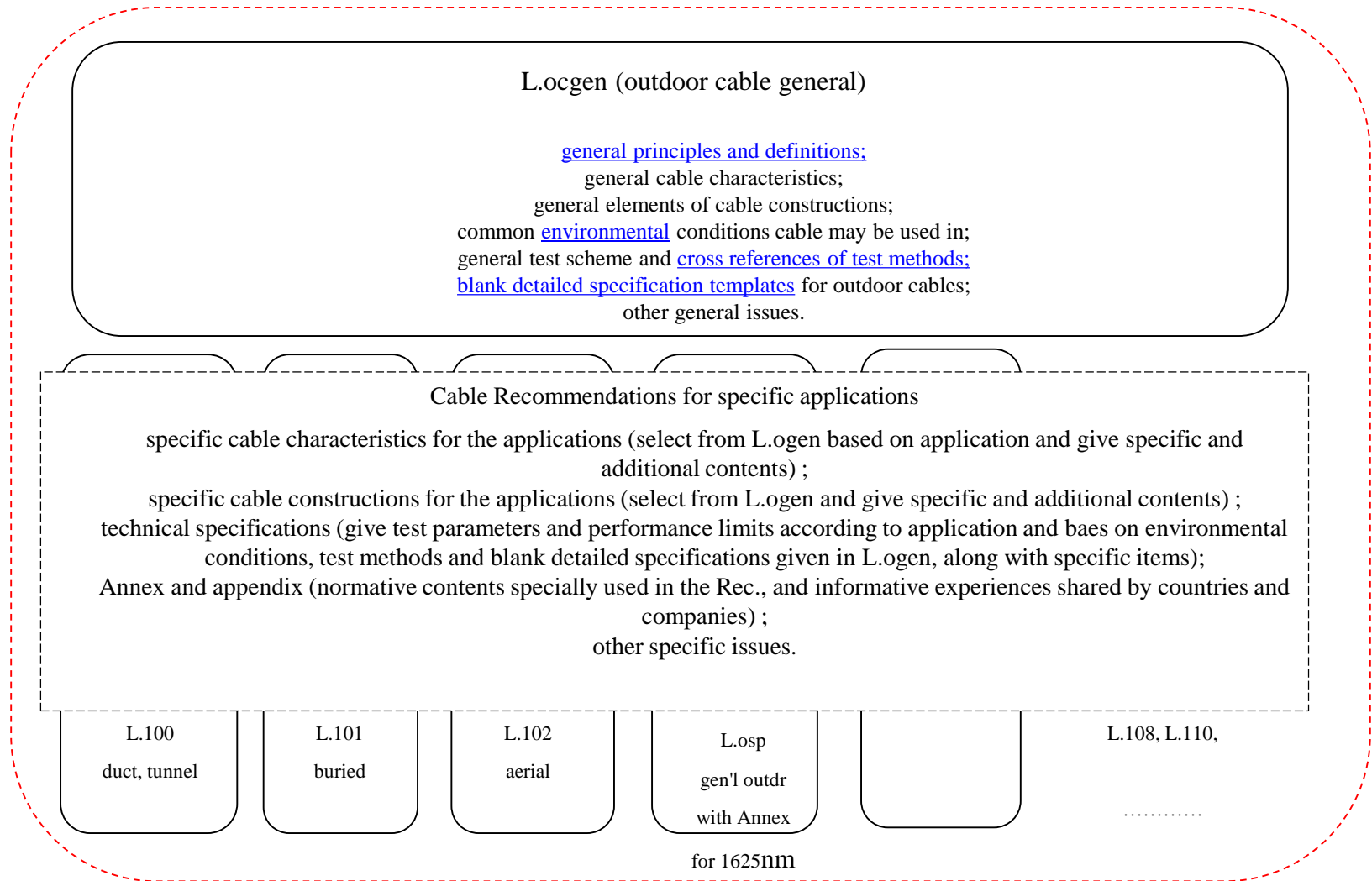



## Задержка сигналов в световодах для сетей 5G

В рамках дискуссий по внедрению новых оптических технологий на телекоммуникационных сетях, было подчеркнуто, что развертывание сетей 4G и 5G вызывает необходимость использования большого количества новых волоконных световодов и ОК. Появляется необходимость прокладки ОК непосредственно к базовым станциям систем мобильной связи. Поэтому целесообразно исследовать влияние световодов на задержку сигналов в таких сетях, особенно при изменениях температуры окружающей среды. На заседаниях экспертов по вопросу 5 (Q.5) было отмечено, что задержка в различных типах одномодовых волокон будет меньше 0,5 пс / км / К, даже если мы будем считать относительную разницу в индексе показателя преломления 0,3 - 1,5 %. Q.5 пришел к выводу, что влияние типа волокон на задержку (латентность) будет незначительным.

# New Supplements to ITU-T G-series Recommendations

## **Supplement 41 Design guidelines for optical fibre submarine cable systems**

Supplement 41 to ITU-T G-series Recommendations describes design considerations for repeatered, repeaterless and optically amplified systems supporting SDH and OTN signals in optical submarine cable systems.

## **Supplement 58 Optical transport network module framer interfaces**

Supplement 58 to ITU-T G-series Recommendations describes several interoperable component-to-component multilane interfaces (across different vendors) to connect an optical module (with or without digital signal processor (DSP)) to a framer device in a vendor's equipment supporting 40G, 100G or beyond 100G optical transport network (OTN) interfaces.

## **Supplement 59 Guidance on optical fibre and cable reliability**

Supplement 59 to ITU-T G-series Recommendations provides guidance regarding the long term reliability of cabled optical fibres. This Supplement uses currently accepted models combined with current experience to describe items that can impact the performance of an optical fibre over time. The document describes "optical reliability" for fibres, "mechanical reliability" for fibres and describes how optical cables impact these properties.

## **Supplement 59 to ITU-T G-series Recommendations**

### **Guidance on optical fibre and cable reliability**

Optical cables were first deployed commercially in 1977. Thus, our knowledge of their performance in the field is less than 40 years and much information provided in this Supplement is speculative, although today significant spontaneous fibre breakage in these old fibres is not known. Detailed analysis of attenuation characteristics and mechanical attributes for cabled fibre that have been installed for 25 years indicate that the optical properties are very stable over time. With this background we can use our accumulated field knowledge combined with accelerated aging to estimate the reliability of optical cables.

**Reliability falls into two major categories:**

- **Mechanical reliability (will the fibre break over the cable lifetime)**
- **Optical reliability (will optical transmission be maintained over the cable lifetime)**

It is hard to separate optical fibre reliability from optical cable reliability as the two are intimately related, but in this Supplement we will focus primarily on the fibre attributes and how they relate to cabled optical fibre.

# Направления стандартизации

- **L.404 Field mountable single-mode optical fibre connectors**
- **L.206 Requirements for Passive Optical Nodes: Outdoor Optical Cross-Connect Cabinet**
- **L.108 (ex L.79) Optical fibre cable elements for microduct blowing-installation application**
- **L.156 (ex L.57) Air-assisted installation of optical fibre cable**
- **L.110 Optical Fibre Cables for Direct Surface Application**
- **L.163 Criteria for optical fibre cable installation with minimal existing infrastructure**
- **L.109 (L.60) Construction of optical/metallic hybrid cables**
- **L.207 (ex L.pneid) Passive node elements with automated ID tag detection**
- **L.314 Optical fibre identification for the maintenance of optical access networks**
- **L.315 (ex L.wdc) Water detection in underoptical monitoring system round closures for the maintenance of optical fibre cable networks with optical monitoring system**
- **G.650.3 Test methods for installed single-mode optical fibre cable links**
- **G.651.1 Characteristics of a 50/125  $\mu\text{m}$  multimode graded index optical fibre cable for the optical access network**

# Outdoor Optical Cross-Connect Cabinet

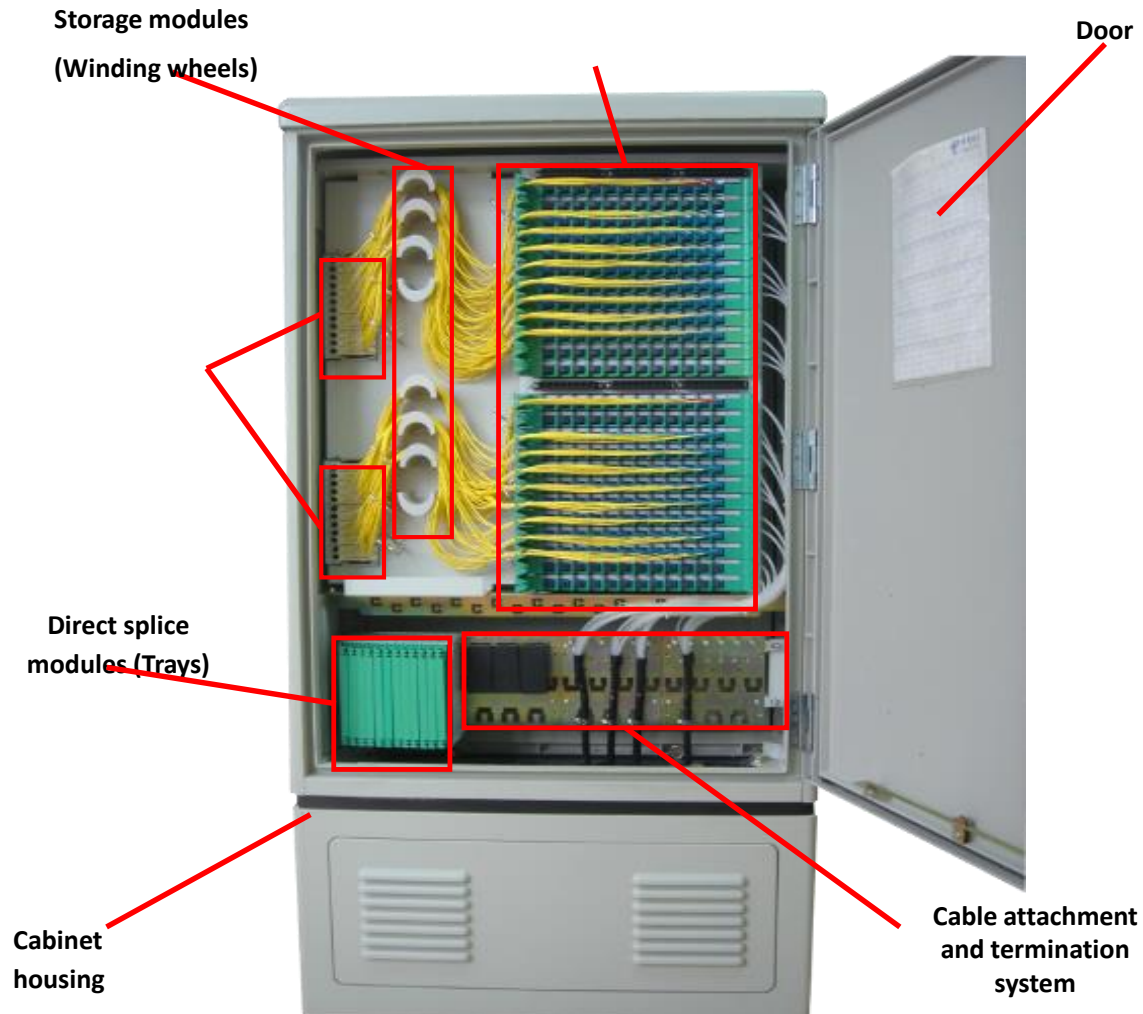

# Высокая загрузка смотровых устройств кабельной канализации



# Outside plant and related indoor installation



# Новые рекомендации серии L

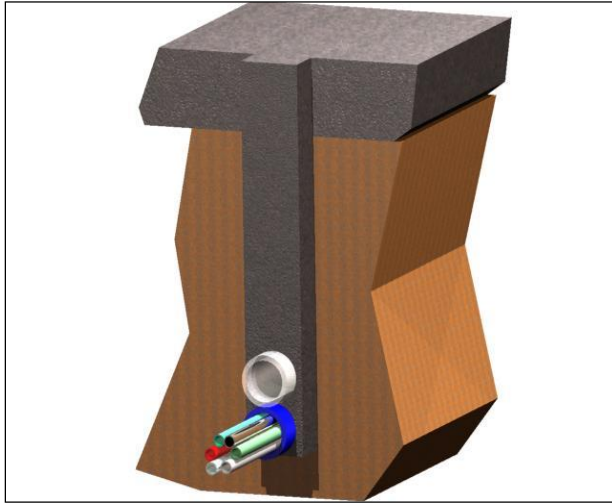

Backfilling

Pipes laying

Suction

Trenching

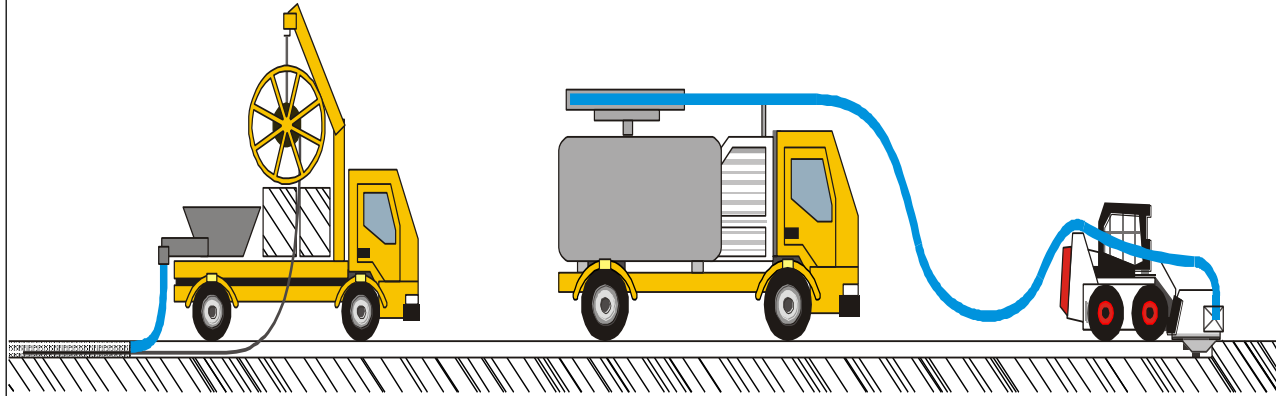

L.83(10)\_F02

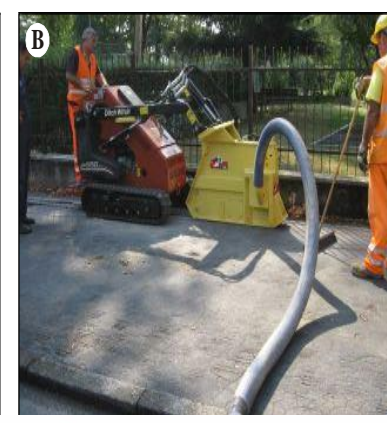



# Новые рекомендации серии L

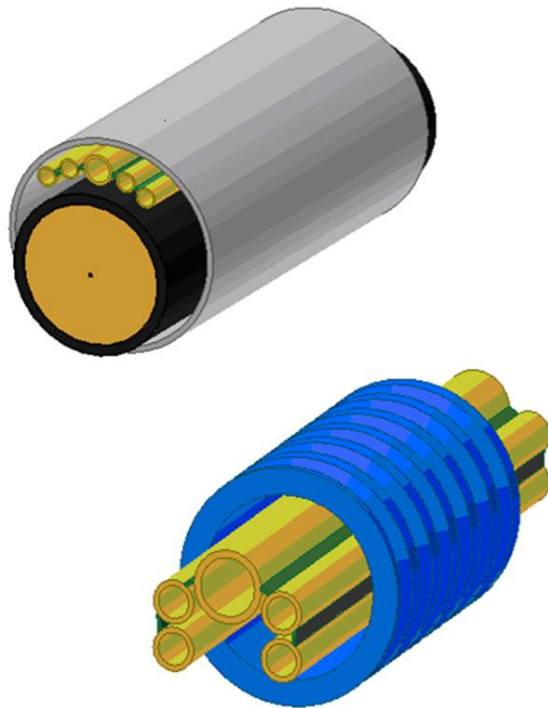

## L.162 Microducts technology and its applications

# L.108 Optical fibre cable elements for microduct blowing-installation application

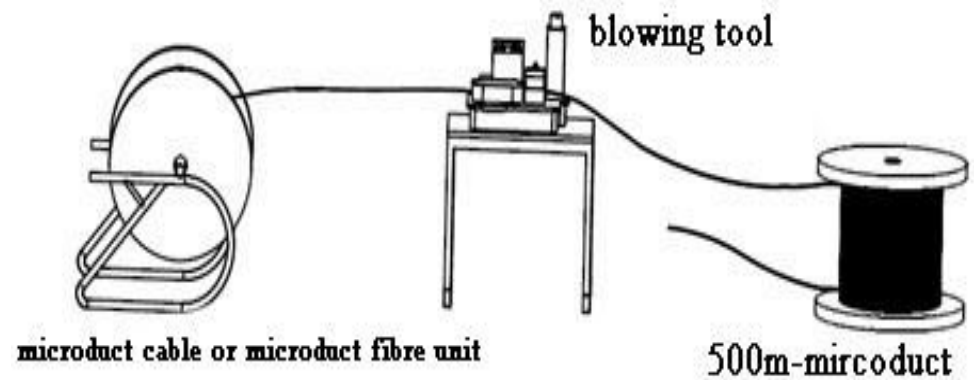
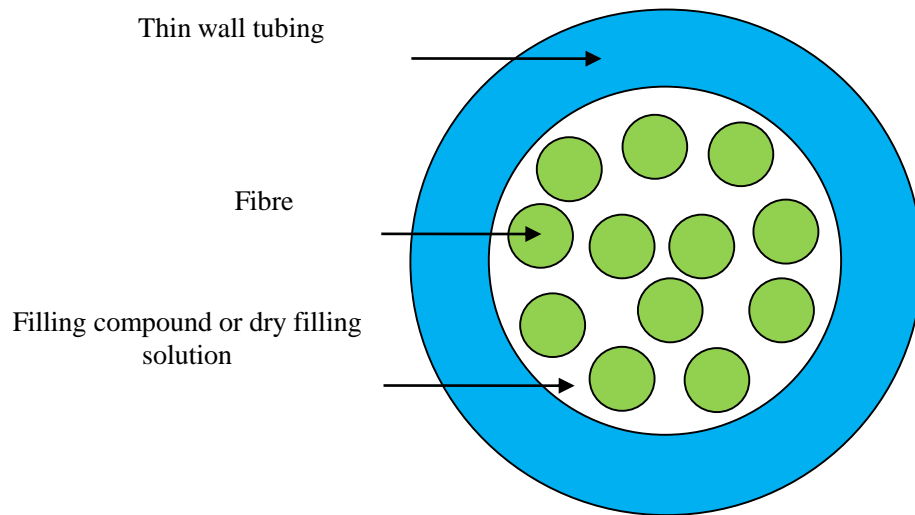

# L.108 Optical fibre cable elements for microduct blowing-installation application

## **Microduct cable**

Microduct cables, often called microcables, may consist of fibres, groupings of fibres, strength members, water blocking materials, sheaths and other appropriate materials. Microduct cable construction and performance is described by [IEC 60794-5-10].

Microduct cables typically have fibre counts ranging from 4 to 288 or more, with a typical outside diameter of 1.5 mm to 10.0 mm or even larger diameters. The units within may consist of single fibres, fibre groupings such as tubes, micromodules or ribbons.

## **Microduct fibre unit**

These units differ from microduct optical fibre cables in that they provide less protection to the fibres that they contain. Microduct fibre unit construction and performance is described by [IEC 60794-5-20].

## **Microducts**

The microducts should be able to resist the pressure differences needed during installation with a blowing technique. They should be circular and uniform in cross-section throughout their length and the inner surface should have a low friction coefficient either by the material used (silicone, etc.) or having profiled ribbing. The inner and outer diameters should be specified.

In all cases, it should be possible to identify each individual microduct throughout its length. Colour coding or marking are common methods for identification.

Microducts can also be put into the interstices of ducts containing other cables.

# L.110 Optical Fibre Cables for Direct Surface Application

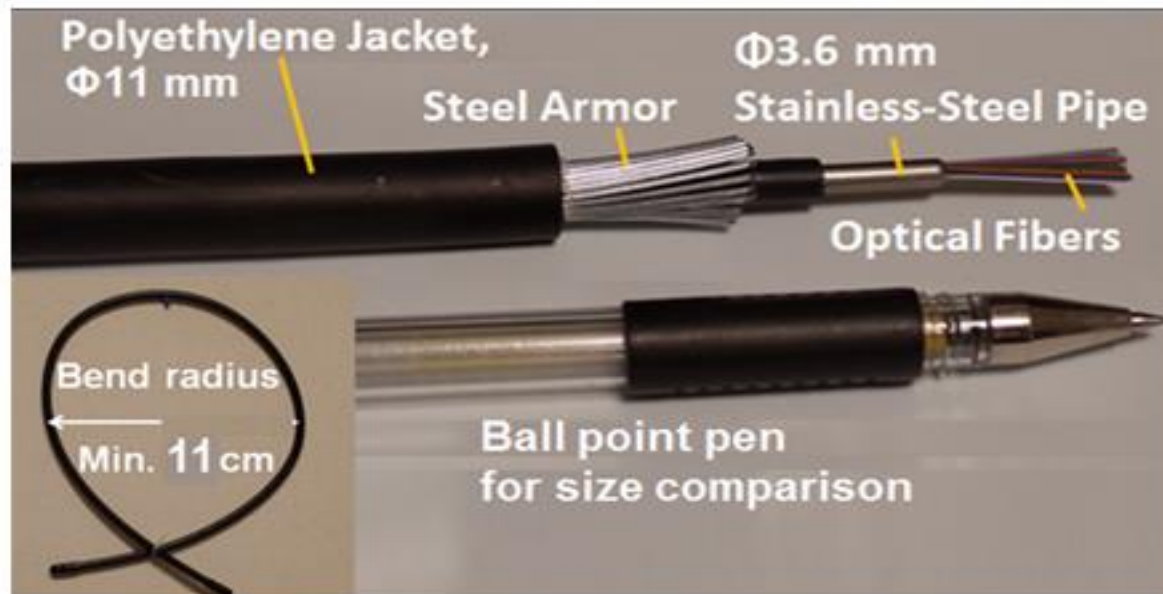
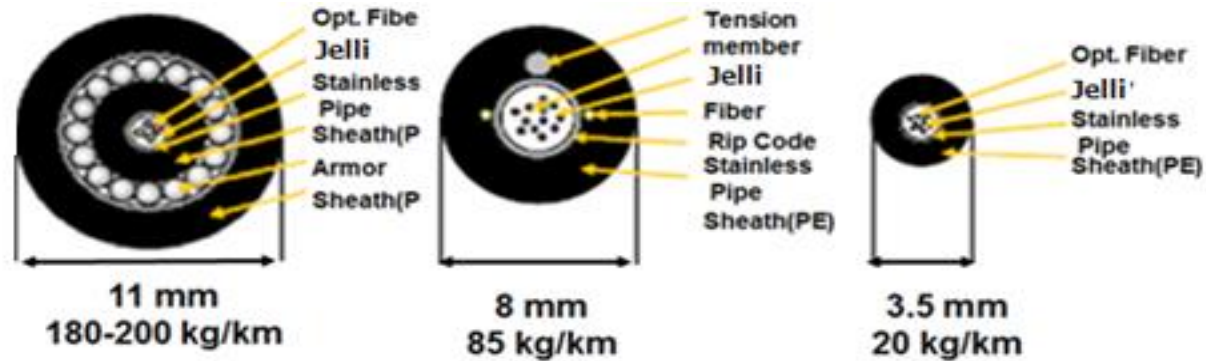

# Optical Fibre Cables for Direct Surface Application

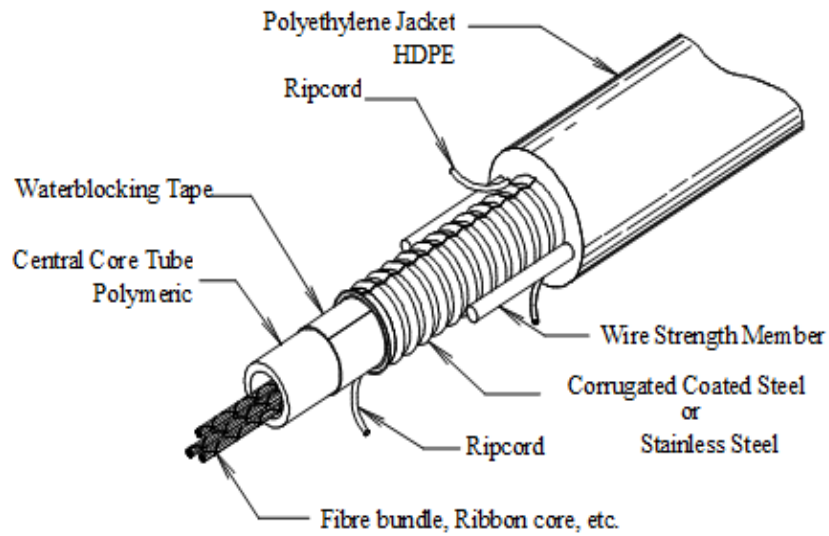

# Recommendation ITU-T L.163 Criteria for optical fibre cable installation with minimal existing infrastructure

Recommendation ITU-T L.163 describes criteria for the installation of optical fibre cables defined in [ITU-T L.110] in remote areas with lack of usual infrastructure for installation including the procedures of cable-route planning, cable selection, cable-installation scheme selection, cable tension and temperature consideration, and the handling, bend protection and river/lake crossing of the cable together with pilot tests and training for installation.

This Recommendation also describes how to mitigate the considerable risks and/or issues to which the optical fibre cable may be exposed when infrastructures are minimal during installation, maintenance and operation procedures.

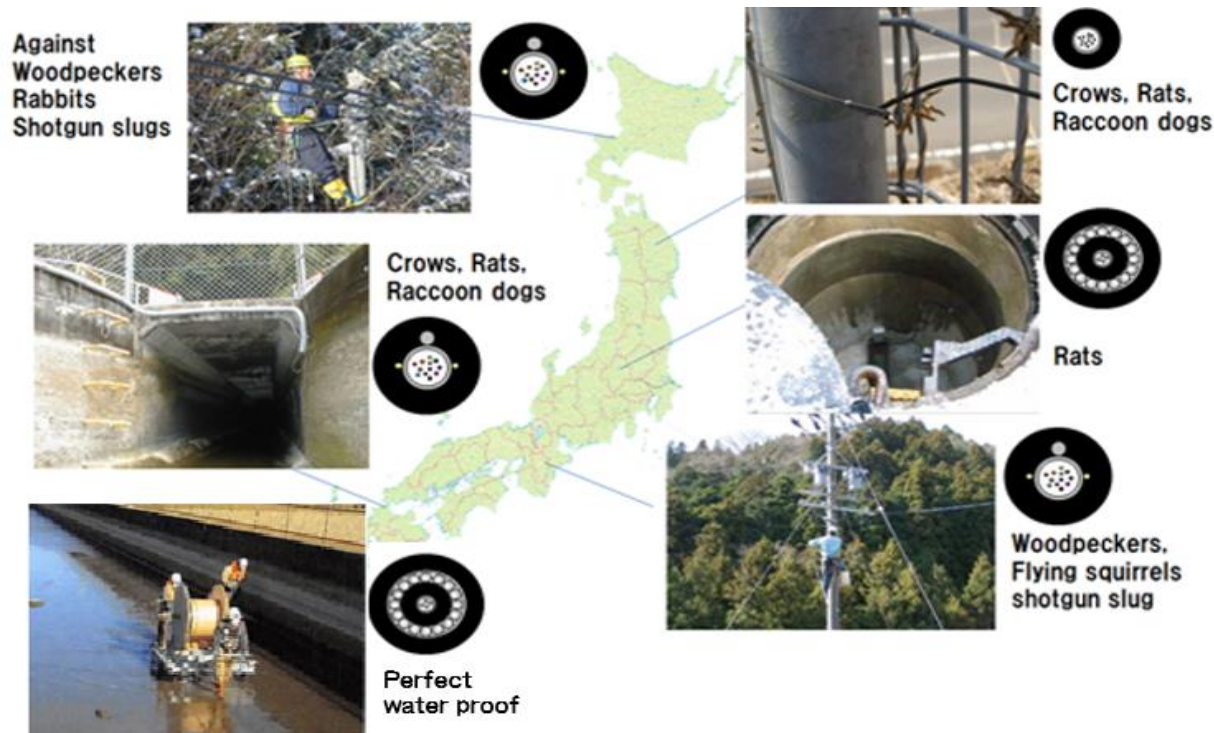

# Опыт NTT



# L.109 Construction of optical/metallic hybrid cables

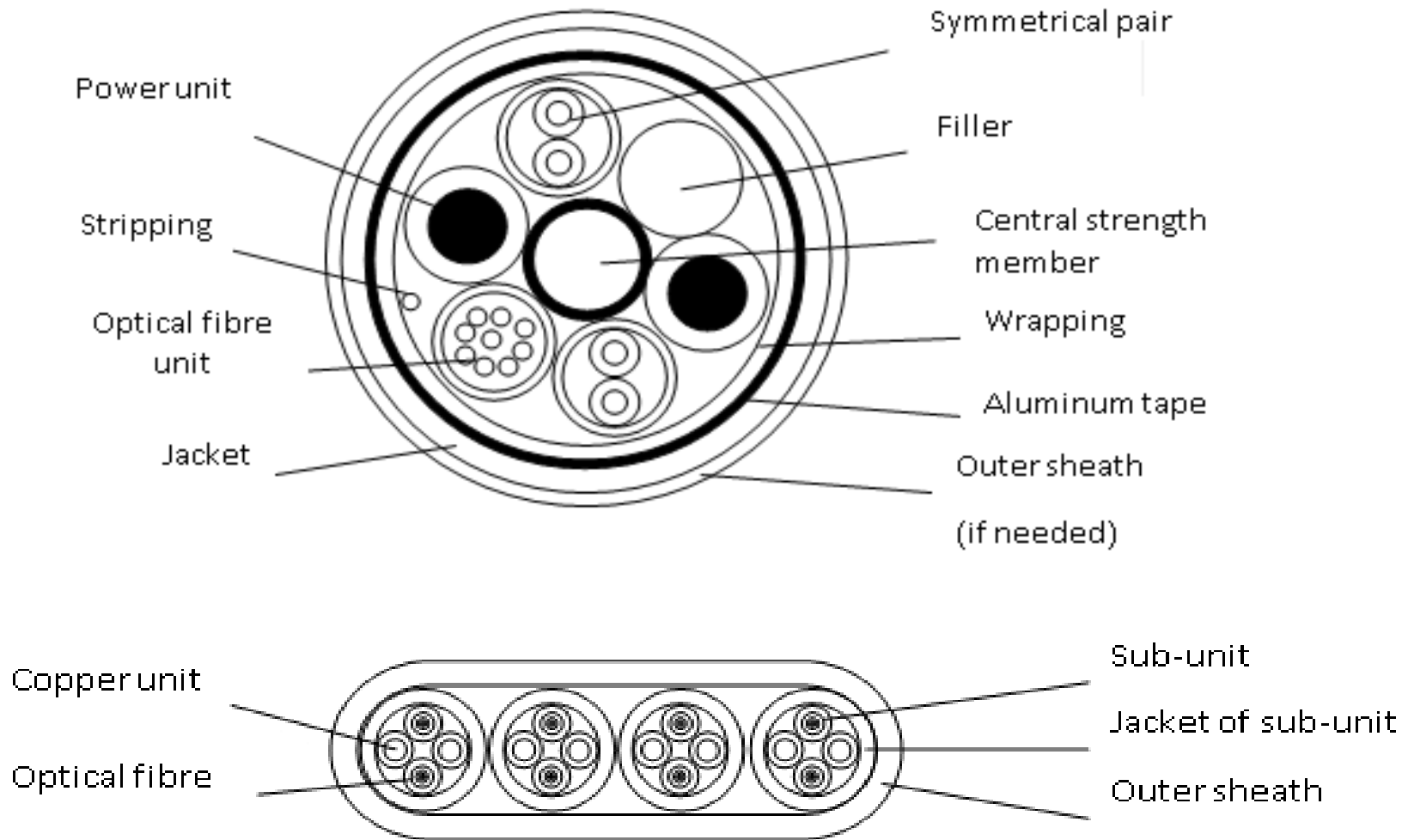



# G.651.1 Characteristics of a 50/125 $\mu\text{m}$ multimode graded index optical fibre cable for the optical access network

## Fibre attributes

Attribute	Detail	Value	Unit
Cladding diameter	Nominal	125	$\mu\text{m}$
	Tolerance	$\pm 1$	$\mu\text{m}$
Core diameter	Nominal	50	$\mu\text{m}$
	Tolerance	$\pm 2.5$	$\mu\text{m}$
Core-cladding concentricity error	Maximum	2	$\mu\text{m}$
Core non-circularity	Maximum	6	%
Cladding non-circularity	Maximum	2	%
Numerical aperture	Nominal	0.20	
	Tolerance	$\pm 0.015$	
Macrobend loss (Notes 1 and 2)	Radius	15	mm
	Number of turns	2	
	Maximum at 850 nm	1.0	dB
	Maximum at 1300 nm	1.0	dB
Proof stress	Minimum	0.69	GPa
Modal bandwidth-length product for overfilled launch	Minimum at 850 nm	500	MHz · km
	Minimum at 1300 nm	500	MHz · km
Chromatic dispersion coefficient (Note 3)	$\lambda_{0\text{min}}$	1295	nm
	$\lambda_{0\text{max}}$	1340	nm
	$S_{0\text{max}}$ for $1295 \leq \lambda_0 \leq 1310$ nm	$\leq 0.105$	ps/nm <sup>2</sup> · km
	$S_{0\text{max}}$ for $1310 \leq \lambda_0 \leq 1340$ nm	$\leq 375 \times (1590 - \lambda_0) \times 10^{-6}$	ps/nm <sup>2</sup> · km

## Cable attributes

Attribute	Detail	Value
Attenuation coefficient	Maximum at 850 nm	3.5
	Maximum at 1300 nm	1.0

# L.207 Passive node elements with automated ID tag detection

## Scope

This Recommendation addresses the general features, characterization and performance requirements for passive node elements with ID tag detection which supports automatic information collection on fibre connectivity. This Recommendation focuses on both indoor and outside plant deployment conditions and includes the following:

- Functional requirements
- Automated ID tag detection performance requirements
- Mechanical and electrical/optical interface requirements

В результате стремительного роста FTTx главными задачами для операторов сетей электросвязи стали оперативное развертывание и эффективное техническое обслуживание новой пассивной волоконно-оптической кабельной сети (то есть оптической распределительной сети, ODN). Глобальная отрасль связи разрабатывает элементы пассивных узлов с автоматическим обнаружением идентификационной метки, чтобы сделать возможным автоматический сбор информации о волоконно-оптическом подключении для обеспечения более эффективной прокладки, эксплуатации и технического обслуживания волоконно-оптических сетей.

В Рекомендации МСЭ-Т L.207 основное внимание уделено аспектам аппаратной части этого типа элементов пассивных узлов и описанию общих функций, параметров и спецификаций эксплуатационных характеристик элементов узлов с автоматическим обнаружением идентификационной метки, включая условия окружающей среды, функциональные требования, эксплуатационные требования, а также требования к механическим и электрическим/оптическим интерфейсам.

# Recommendation ITU-T L.314 Optical fibre identification for the maintenance of optical access networks

## Summary

Recommendation ITU-T L.314 deals with important considerations with respect to the requirements for an optical fibre identification technique used for construction and maintenance work in optical access networks by detection of leaky light waves.

Central Office

Customers' Premises

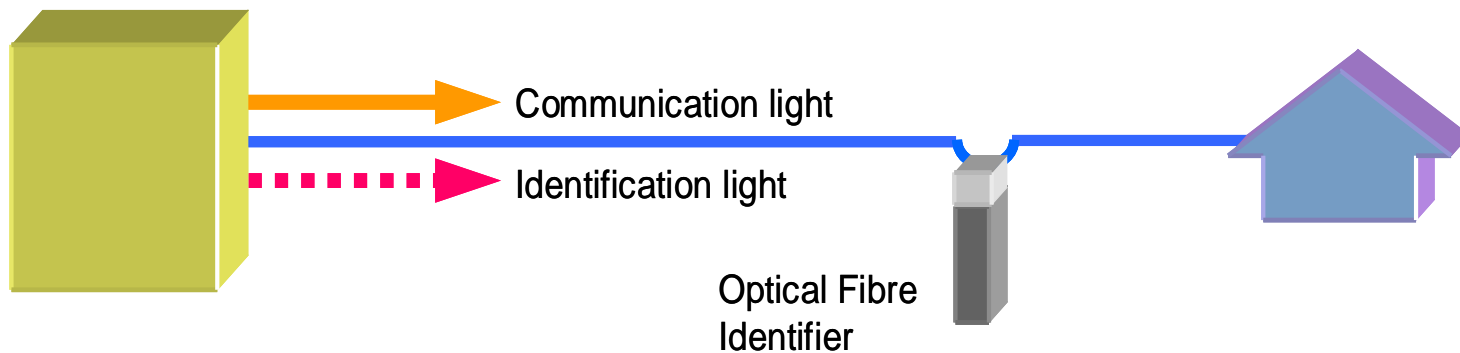

Configuration for optical fibre identification

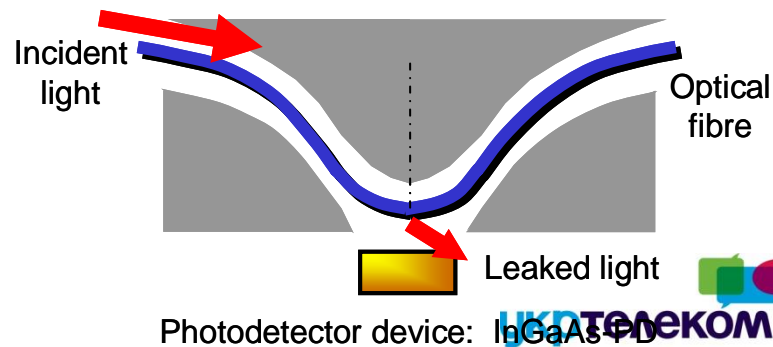

# L.315 Water detection in underground closures/cabinets for the maintenance of optical fibre cable networks

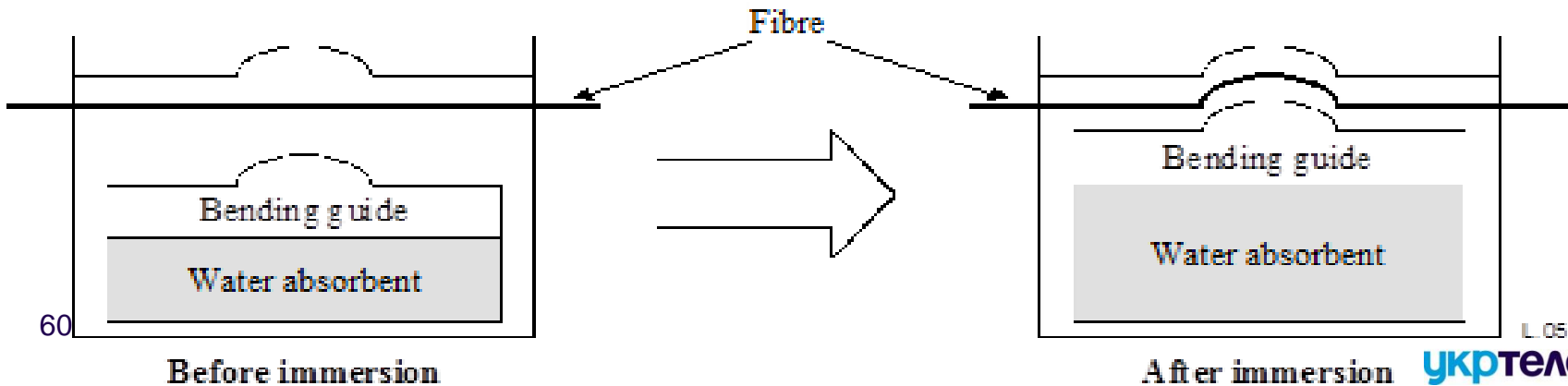
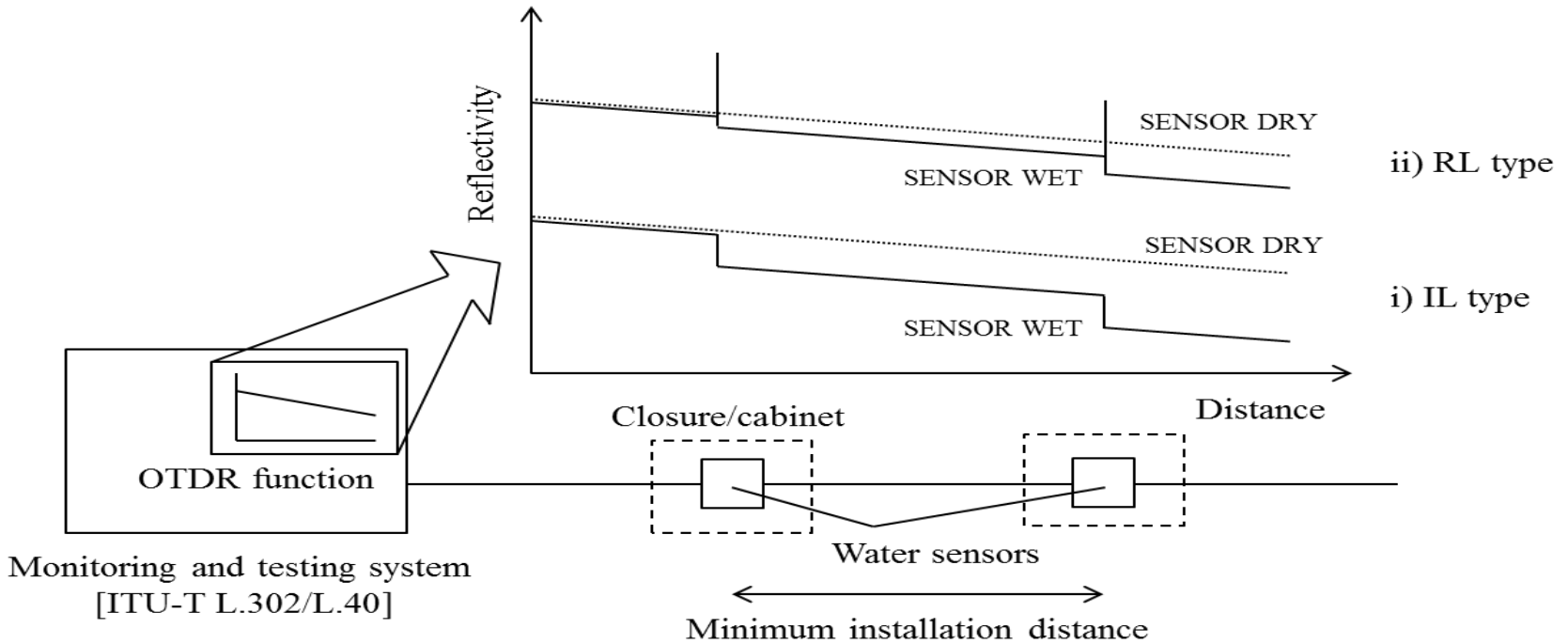

# GSTR-TN5G

## Transport network architecture

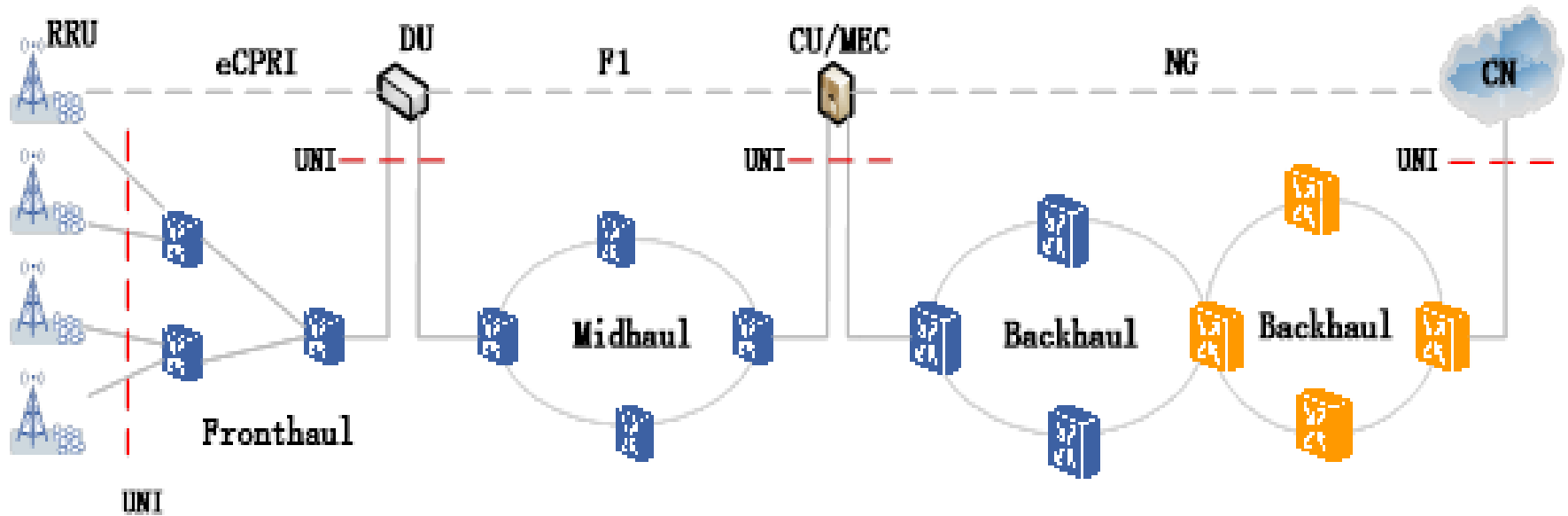

- CU Central Unit
- DU Distributed Unit
- RRU Remote Radio Unit
- Midhaul midhaul is the network between DU and CU (F interface)

# What should you be looking for?



# Draft New Recommendation ITU-T L.o.ha «Optical fibre cables for in-home applications»



China Telecom 中國聯通

This Recommendation aims to provide the requirements of optical fibre cables for in-home applications. ~~to requirements of optical fibre cables in traditional “indoor” applications, the requirements of cables in “in-home”~~ applications have their own specialized characteristics. This new recommendation describes characteristics, cable construction and test methods of optical fibres and cables for in-home applications.

## Application Case I

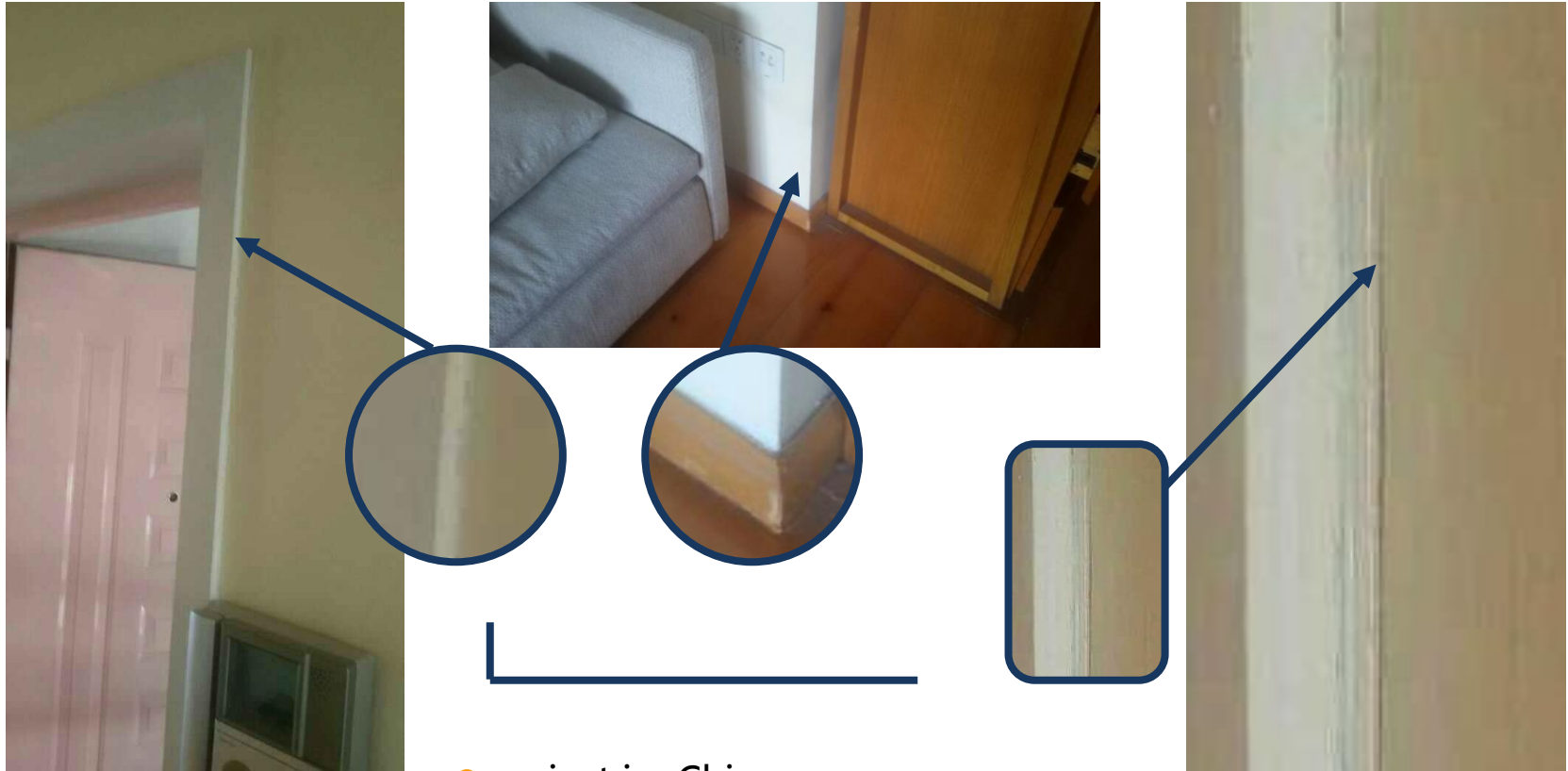

● project in China

# new Recommendation “Optical fibre cables for in-home directly wall surface applications”

## Application Case II



- project in China



# Новые типы кабелей

## Spider Web Ribbon & Wrapping Tube Cables

Мы объединили **лучшее** от кабелей со свободной укладкой и с ленточным волокном и добавили **ещё привлекательных характеристик**.

Кабель со свободной укладкой	Ленточные кабели	Кабель с паутинообразной лентой
<p>Свободные одиночные волокна Легко свернуть</p> 	<p>Волокна в ленте <b>Нельзя свернуть</b></p> 	<p>Паутинообразное волокно Легко свернуть</p> 
<p><b>Сложная многоволоконная сварка</b></p>	<p>Простая многоволоконная сварка</p>	<p>Простая многоволоконная сварка</p>
 <p><b>Заполнен гидрофобом</b></p>	 <p><b>Заполнен гидрофобом</b></p>	 <p><b>Абсолютно сухой</b></p>

# SpiderWeb Ribbon Design and Functionality

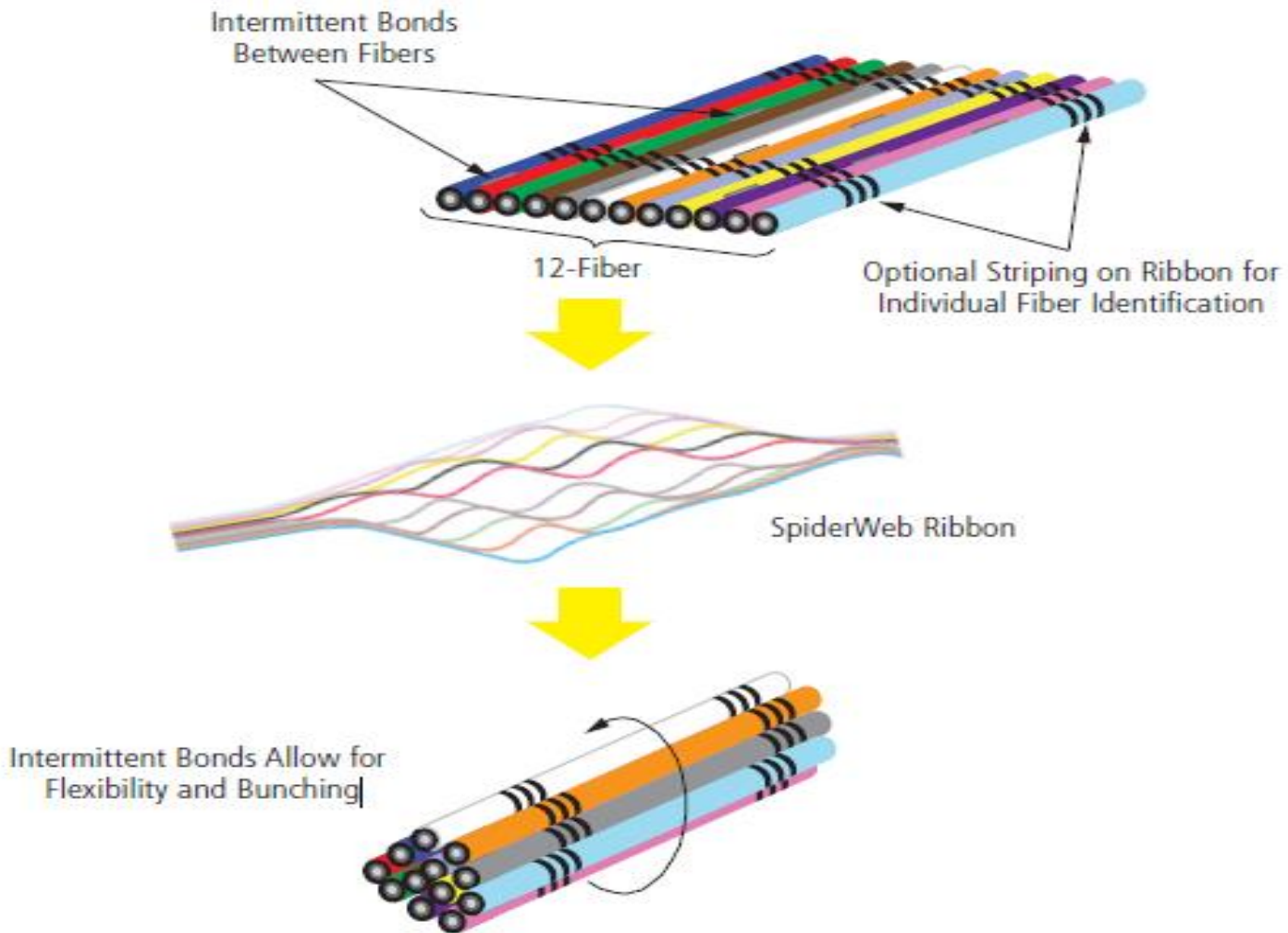

# Buffer Tube High Density Cable: Traditional versus New

## New 200 $\mu$ m Micro Cable versus Traditional Loose Tube

- Construction
  - ✓ Glass remains the same (125 microns)
  - ✓ Telcordia GR-20 and IEC 60794-5-10 compliant
  - ✓ Dry-blocked core made up of six buffer tubes SZ-stranded around central strength member
  - ✓ Kink-resistant gel-filled buffer tubes contain multiple 12-fiber sets of color-coded fibers.
  - ✓ Fibers are arranged in 12-fiber sets with each being identified by dual color-coded binder threads



288-F with 200 $\mu$ m SM  
8.0mm (O.D.) in  
10 mm (I.D.) micro-duct<sub>11</sub>

**Благодарю за  
внимание!**  
vkatok@ukrtelecom.ua



[www.ukrtelecom.ua](http://www.ukrtelecom.ua)